

Globe Double-life  
Globe Double-life  
Globe Double-life  
Globe Double-life  
Globe Double-life



*Soft Opal*



**E27** **ø60mm**  
soft-opale, soft opal, softopaal, opale tenue, softopal

|      |      |    |        |        |        |        |         |
|------|------|----|--------|--------|--------|--------|---------|
| 25W  | 86mm | 12 | 103.21 | € 0,99 | € 1,04 | € 1,14 | 10321.0 |
| 40W  | 86mm | 12 | 103.41 | € 0,99 | € 1,04 | € 1,14 |         |
| 60W  | 86mm |    |        | € 0,99 | € 1,04 | € 1,14 |         |
| 100W | 86mm |    |        |        |        |        |         |

|                               | <b>(F)</b>                 | <b>(GB)</b>               | <b>(NL)</b>                           | <b>(I)</b>                | <b>(D)</b>     |
|-------------------------------|----------------------------|---------------------------|---------------------------------------|---------------------------|----------------|
| 1  Watt                       | puissance (W)              | Performance               | prestatie                             | Potenza                   | Leistung       |
| 2  Amp                        | ampérage                   | amp                       | ampere                                | ampere                    | Ampér          |
| 3  longueur / hauteur         | Length/height              | lengte / hoogte           | lunghezza/altezza                     | Länge / Höhe              |                |
| 4  longueur, largeur, hauteur | Length, width, height      | lengte , breedte , hoogte | lunghezza, larghezza, altezza         | Länge, Breite, Höhe       |                |
| 5  plage de puissance         | Scope of performance       | prestatiebereik           | campo di potenza                      | Leistungsbereich          |                |
| 6  faisceau d'éclairage       | Wave angle                 | uitvalshoek               | angolo d'illuminazione                | Ausstrahlwinkel           |                |
| 7  emballage brochable        | SB packaging               | showverpakking voor haak  | confezione SB                         | SB-Verpackung             |                |
| 8  unité de conditionnement   | Packaging unit             | verpakkingseenheid        | unità d'imballaggio                   | Verpackungseinheit        |                |
| 9  # No.                      | code article               | Article no.               | artikelnummer                         | numero di articolo        | Artikel Nummer |
| 10  code EAN                  | EAN code                   | EAN-Code                  | codice EAN                            | EAN-Code                  |                |
| 11  voir tarif en annexe      | Price scale see attachment | prijstaffel zie bijlage   | differenziazione prezzi vedi allegato | Preisstaffel siehe Anlage |                |

|  |                       |                  |                       |                          |                       |
|--|-----------------------|------------------|-----------------------|--------------------------|-----------------------|
|  | filament axial        | axial filament   | Axialdraad            | filamento assiale        | Axialwendel           |
|  | protection éclatement | Space protection | breukbeveiliging      | protezione contro guasti | Platzschutz           |
|  | culot                 | Base             | bodemplaat            | attacco                  | Socket                |
|  | durée de vie moyenne  | Medium life-span | gemiddelde levensduur | durata media             | mittlerer Lebensdauer |



Globe  
Globe  
Globe  
Globe  
Globe

*Soft Opal*



**E27** **ø125mm**

*soft-opale, soft opal, softopaal, opale tenue, softopal*

|      |       |   |        |         |
|------|-------|---|--------|---------|
| 40W  | 180mm | 6 | 100.40 | 10040.0 |
| 60W  | 180mm | 6 | 100.60 | 10060.8 |
| 75W  | 180mm | 6 | 100.70 | 10070.7 |
| 100W | 180mm | 6 | 100.00 | 10000.4 |

ECO Globe  
ECO Globe  
ECO globe  
ECO Globe  
TIP-ECO Globe



**E27** **ø95mm**

*opale, opal, opaal, opale, opal*

|      |       |   |        |         |
|------|-------|---|--------|---------|
| 40W  | 137mm | 4 | 191.74 | 19174.3 |
| 60W  | 137mm | 4 | 191.76 | 19176.7 |
| 100W | 137mm | 4 | 191.70 | 19170.5 |

Globe  
Globe  
Globe  
Globe  
Globe

*Soft Opal*



**E27** **ø95mm**

*soft-opale, soft opal, softopaal, opale tenue, softopal*

|      |       |   |         |         |
|------|-------|---|---------|---------|
| 25W  | 137mm | 4 | 101.21  | 10121.6 |
| 40W  | 137mm | 4 | 101.401 | 10140.7 |
| 60W  | 137mm | 4 | 101.601 | 10160.5 |
| 75W  | 137mm | 4 | 101.701 | 10170.4 |
| 100W | 137mm | 4 | 101.001 | 10100.1 |



**E27** **ø80mm**

*soft-opale, soft opal, softopaal, opale tenue, softopal*

|      |       |   |        |         |
|------|-------|---|--------|---------|
| 25W  | 123mm | 5 | 102.20 | 10220.6 |
| 40W  | 123mm | 5 | 102.40 | 10240.4 |
| 60W  | 123mm | 5 | 102.60 | 10260.2 |
| 100W | 123mm | 5 | 102.00 | 10200.8 |

Mini-globe  
Mini-Globe  
miniglobe  
Miniglobe  
Miniglobe

*Soft Opal*



**E27** **ø60mm**

*soft-opale, soft opal, softopaal, opale tenue, softopal*

|     |      |   |        |         |
|-----|------|---|--------|---------|
| 25W | 86mm | 6 | 103.20 | 10320.3 |
| 40W | 86mm | 6 | 103.40 | 10340.1 |
| 60W | 86mm | 6 | 103.60 | 10360.9 |



2 - 54



55 - 65

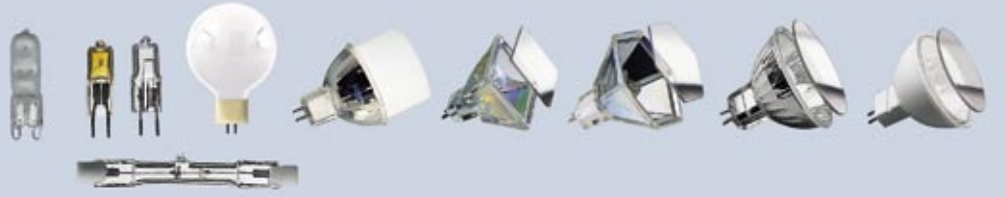

66 - 103



104 - 112



113 - 132



Globe Double-life  
Globe Double-life  
Globe Double-life  
Globe Double-life  
Globe Double-life



*Soft Opal*

**E27****ø60mm***soft-opale, soft opal, softopaal, opale tenue, softopal*

|      |      |    |               |         |
|------|------|----|---------------|---------|
| 25W  | 86mm | 12 | <b>103.21</b> | 10321.0 |
| 40W  | 86mm | 12 | <b>103.41</b> | 10341.8 |
| 60W  | 86mm | 12 | <b>103.61</b> | 10361.6 |
| 100W | 86mm | 12 | <b>103.01</b> | 10301.2 |

Sphérique  
Ball Lamp  
kogellamp  
Lampadina a goccia  
Tropfenlampe

*Soft Opal*

**E27****ø45mm***soft-opale, soft opal, softopaal, opale tenue, softopal*

|     |      |   |               |         |
|-----|------|---|---------------|---------|
| 25W | 70mm | 8 | <b>104.20</b> | 10420.0 |
| 40W | 70mm | 8 | <b>104.40</b> | 10440.8 |
| 60W | 70mm | 8 | <b>104.60</b> | 10460.6 |

Sphérique Krypton  
Krypton Ball Lamp  
kogellamp Krypton  
Lampada di cripto a goccia  
Tropfenlampe Krypton

**Krypton**  
+10% *Soft Opal*

**E27****ø45mm***krypton soft-opale, krypton soft opal, Krypton softopaal, cripto opale tenue, Krypton softopal*

|     |      |   |               |         |
|-----|------|---|---------------|---------|
| 25W | 70mm | 8 | <b>104.21</b> | 10421.7 |
| 40W | 70mm | 8 | <b>104.41</b> | 10441.5 |
| 60W | 70mm | 8 | <b>104.61</b> | 10461.3 |

Mini-globe  
Mini-Globe  
miniglobe  
Miniglobe  
Miniglobe

*Soft Opal*

**E14****ø60mm***soft-opale, soft opal, softopaal, opale tenue, softopal*

|     |      |   |               |         |
|-----|------|---|---------------|---------|
| 25W | 91mm | 6 | <b>106.20</b> | 10620.4 |
| 40W | 91mm | 6 | <b>106.40</b> | 10640.2 |
| 60W | 91mm | 6 | <b>106.60</b> | 10660.0 |

**E14****ø50mm***soft-opale, soft opal, softopaal, opale tenue, softopal*

|     |      |   |               |         |
|-----|------|---|---------------|---------|
| 25W | 80mm | 8 | <b>105.20</b> | 10520.7 |
| 40W | 80mm | 8 | <b>105.40</b> | 10540.5 |



**Sphérique**  
**Ball Lamp**  
**kogellamp**  
**Lampadina a goccia**  
**Tropfenlampe**

*Soft Opal*

**E14****ø45mm***soft-opale, soft opal, softopaal, opale tenue, softopal*

|     |      |   |        |         |
|-----|------|---|--------|---------|
| 15W | 75mm | 8 | 432.10 | 43210.5 |
| 25W | 75mm | 8 | 432.20 | 43220.4 |
| 40W | 75mm | 8 | 432.40 | 43240.2 |
| 60W | 75mm | 8 | 432.60 | 43260.0 |

**Sphérique Krypton**  
**Krypton Ball Lamp**  
**kogellamp Krypton**  
**Lampada di cripto a goccia**  
**Tropfenlampe Krypton**

**Krypton**  
 +10%

*Soft Opal*

**E14****ø45mm***krypton soft-opale, krypton soft opal, Krypton softopaal, cripto opale tenue, Krypton softopal*

|     |      |   |        |         |
|-----|------|---|--------|---------|
| 25W | 75mm | 8 | 432.21 | 43221.1 |
| 40W | 75mm | 8 | 432.41 | 43241.9 |
| 60W | 75mm | 8 | 432.61 | 43261.7 |





Globe  
Globe  
Globe  
Globe  
Globe



**E27** **ø125mm**

*clair, clear, helder, chiaro, klar*

|     |       |   |        |         |
|-----|-------|---|--------|---------|
| 60W | 180mm | 6 | 110.60 | 11060.7 |
|-----|-------|---|--------|---------|



**E27** **ø95mm**

*clair, clear, helder, chiaro, klar*

|     |       |   |        |         |
|-----|-------|---|--------|---------|
| 60W | 138mm | 4 | 111.60 | 11160.4 |
|-----|-------|---|--------|---------|



**E27** **ø80mm**

*clair, clear, helder, chiaro, klar*

|     |       |   |        |         |
|-----|-------|---|--------|---------|
| 40W | 123mm | 5 | 112.40 | 11240.3 |
|-----|-------|---|--------|---------|

Globe Double-life  
Globe Double-life  
Globe Double-life  
Globe Double-life  
Globe Double-life



**E27** **ø60mm**

*clair, clear, helder, chiaro, klar*

|      |      |    |        |         |
|------|------|----|--------|---------|
| 25W  | 86mm | 12 | 113.20 | 11320.2 |
| 40W  | 86mm | 12 | 113.40 | 11340.0 |
| 60W  | 86mm | 12 | 113.60 | 11360.8 |
| 100W | 86mm | 12 | 113.00 | 11300.4 |

Sphérique  
Ball Lamp  
kogellamp  
Lampadina a goccia  
Tropfenlampe



**E27** **ø45mm**

*clair, clear, helder, chiaro, klar*

|     |      |   |        |         |
|-----|------|---|--------|---------|
| 15W | 70mm | 8 | 118.10 | 11810.8 |
| 25W | 70mm | 8 | 118.20 | 11820.7 |
| 40W | 70mm | 8 | 118.40 | 11840.5 |
| 60W | 70mm | 8 | 118.60 | 11860.3 |



**E14** **ø45mm**

*clair, clear, helder, chiaro, klar*

|     |      |   |        |         |
|-----|------|---|--------|---------|
| 15W | 75mm | 8 | 117.10 | 11710.1 |
| 25W | 75mm | 8 | 117.20 | 11720.0 |
| 40W | 75mm | 8 | 117.40 | 11740.8 |
| 60W | 75mm | 8 | 117.60 | 11760.6 |



Globe  
Globe  
Globe  
Globe  
Globe



**E27** **ø95mm**

*satín, satín, satijn, satinato, satín*

|      |       |   |        |         |
|------|-------|---|--------|---------|
| 40W  | 138mm | 4 | 121.40 | 12140.5 |
| 60W  | 138mm | 4 | 121.60 | 12160.3 |
| 100W | 138mm | 4 | 121.00 | 12100.9 |



**E27** **ø80mm**

*satín, satín, satijn, satinato, satín*

|     |       |   |        |         |
|-----|-------|---|--------|---------|
| 40W | 123mm | 5 | 122.40 | 12240.2 |
| 60W | 123mm | 5 | 122.60 | 12260.0 |

Mini-globe  
Mini-Globe  
miniglobe  
Miniglobe  
Miniglobe



**E27** **ø60mm**

*satín, satín, satijn, satinato, satín*

|     |      |   |        |         |
|-----|------|---|--------|---------|
| 40W | 86mm | 6 | 123.40 | 12340.9 |
| 60W | 86mm | 6 | 123.60 | 12360.7 |



**E14** **ø60mm**

*satín, satín, satijn, satinato, satín*

|     |      |   |        |         |
|-----|------|---|--------|---------|
| 25W | 91mm | 6 | 125.20 | 12520.5 |
| 40W | 91mm | 6 | 125.40 | 12540.3 |

Globe Double-life  
Globe Double-life  
Globe Double-life  
Globe Double-life  
Globe Double-life



**E27** **ø60mm**

*dépoli, matt, mat, interno opaco, imatt*

|      |      |    |        |         |
|------|------|----|--------|---------|
| 25W  | 86mm | 12 | 123.22 | 12322.5 |
| 40W  | 86mm | 12 | 123.42 | 12342.3 |
| 60W  | 86mm | 12 | 123.62 | 12362.1 |
| 100W | 86mm | 12 | 123.02 | 12302.7 |

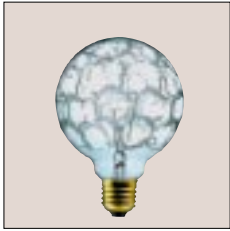

Globe  
Globe  
Globe  
Globe  
Globe

**E27****ø95mm***givr  clair, clear kroko-ice, craquel  helder, krakl  chiaro, Krokoeis klar*

60W

138mm

4

**141.61**

14161.8

**E27****ø80mm***givr  clair, clear kroko-ice, craquel  helder, krakl  chiaro, Krokoeis klar*

40W

123mm

5

**142.41**

14241.7

60W

123mm

5

**142.61**

14261.5

Mini-globe  
Mini-Globe  
miniglobe  
Miniglobe  
Miniglobe

**E14****ø50mm***givr  clair, clear kroko-ice, craquel  helder, krakl  chiaro, Krokoeis klar*

25W

80mm

8

**144.21**

14421.3

40W

80mm

8

**144.41**

14441.1

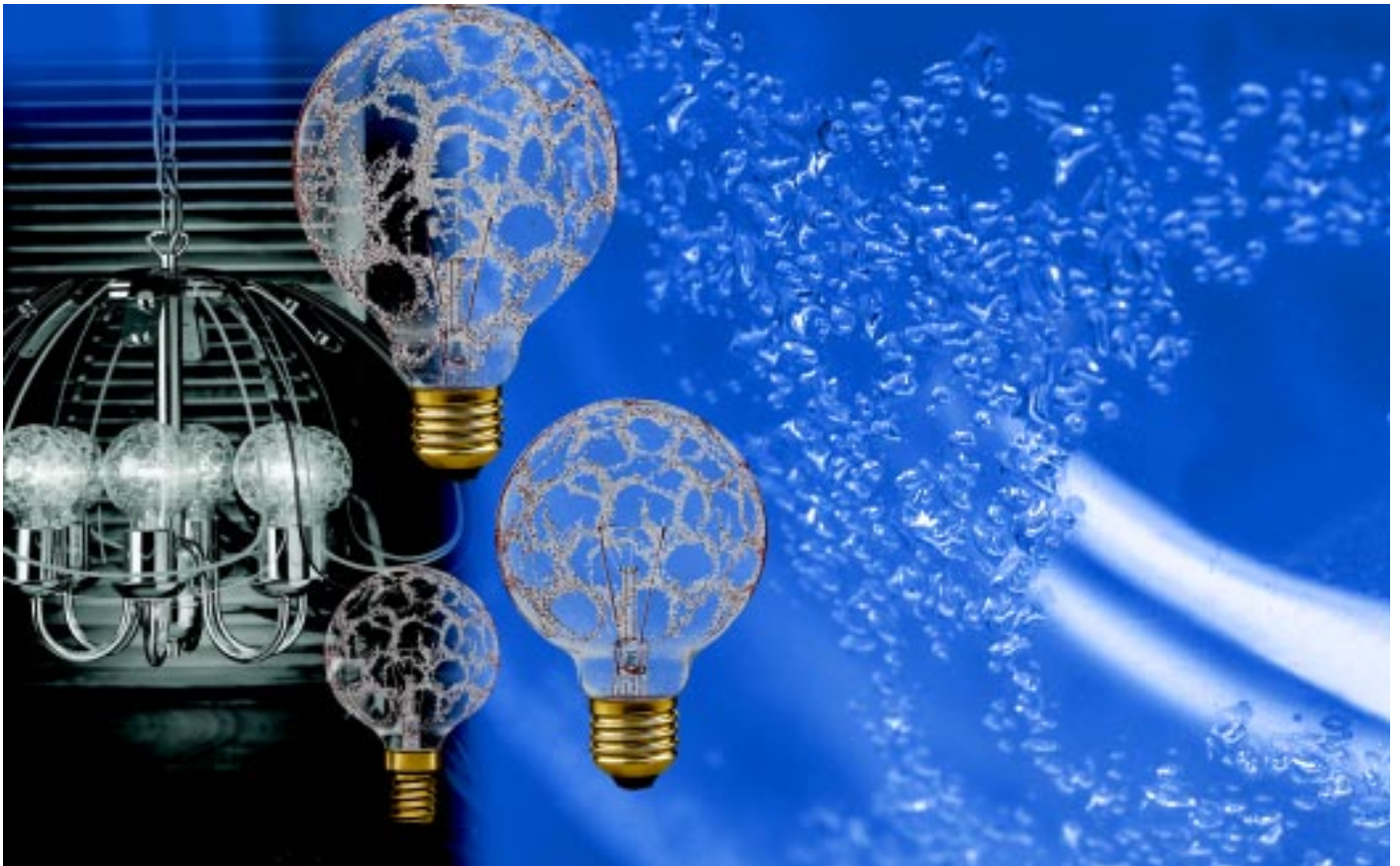



## Globe

**E27** **ø125mm***givrè doré, gold kroko-ice, craquelé goud, kraklè dorato, Krokoeis gold*

|      |       |   |               |         |
|------|-------|---|---------------|---------|
| 40W  | 180mm | 6 | <b>140.40</b> | 14040.6 |
| 60W  | 180mm | 6 | <b>140.60</b> | 14060.4 |
| 100W | 180mm | 6 | <b>140.00</b> | 14000.0 |

**E27** **ø95mm***givrè doré, gold kroko-ice, craquelé goud, kraklè dorato, Krokoeis gold*

|      |       |   |               |         |
|------|-------|---|---------------|---------|
| 40W  | 138mm | 4 | <b>141.40</b> | 14140.3 |
| 60W  | 138mm | 4 | <b>141.60</b> | 14160.1 |
| 100W | 138mm | 4 | <b>141.00</b> | 14100.7 |

**E27** **ø80mm***givrè doré, gold kroko-ice, craquelé goud, kraklè dorato, Krokoeis gold*

|     |       |   |               |         |
|-----|-------|---|---------------|---------|
| 40W | 123mm | 5 | <b>142.40</b> | 14240.0 |
| 60W | 123mm | 5 | <b>142.60</b> | 14260.8 |

## Mini-globe/ Miniglobe

**E27** **ø60mm***givrè doré, gold kroko-ice, craquelé goud, kraklè dorato, Krokoeis gold*

|     |      |   |               |         |
|-----|------|---|---------------|---------|
| 25W | 86mm | 6 | <b>149.20</b> | 14920.1 |
| 40W | 86mm | 6 | <b>149.40</b> | 14940.9 |
| 60W | 86mm | 6 | <b>149.60</b> | 14960.7 |

**E14** **ø60mm***givrè doré, gold kroko-ice, craquelé goud, kraklè dorato, Krokoeis gold*

|     |      |   |               |         |
|-----|------|---|---------------|---------|
| 25W | 91mm | 6 | <b>143.20</b> | 14320.9 |
| 40W | 91mm | 6 | <b>143.40</b> | 14340.7 |
| 60W | 91mm | 6 | <b>143.60</b> | 14360.5 |

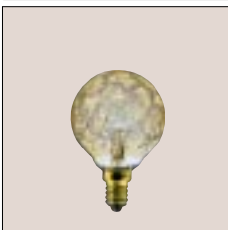
**E14** **ø50mm***givrè doré, gold kroko-ice, craquelé goud, kraklè dorato, Krokoeis gold*

|     |      |   |               |         |
|-----|------|---|---------------|---------|
| 25W | 80mm | 8 | <b>144.20</b> | 14420.6 |
| 40W | 80mm | 8 | <b>144.40</b> | 14440.4 |

Sphérique  
Ball Lamp  
kogellamp  
Lampadina a goccia  
Tropfenlampe**E14** **ø45mm***givrè doré, gold kroko-ice, craquelé goud, kraklè dorato, Krokoeis gold*

|     |      |   |               |         |
|-----|------|---|---------------|---------|
| 25W | 75mm | 8 | <b>145.20</b> | 14520.3 |
| 40W | 75mm | 8 | <b>145.40</b> | 14540.1 |

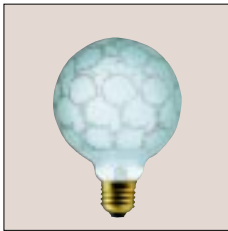

Globe  
Globe  
Globe  
Globe  
Globe

**E27****ø95mm***givré satin, satin kroko-ice, craquelé satijn, kraklè satinato, Krokoeis satin*

|      |       |   |               |         |
|------|-------|---|---------------|---------|
| 40W  | 138mm | 4 | <b>141.49</b> | 14149.6 |
| 60W  | 138mm | 4 | <b>141.69</b> | 14169.4 |
| 100W | 138mm | 4 | <b>141.09</b> | 14109.0 |

**E27****ø80mm***givré satin, satin kroko-ice, craquelé satijn, kraklè satinato, Krokoeis satin*

|     |       |   |               |         |
|-----|-------|---|---------------|---------|
| 40W | 123mm | 5 | <b>142.49</b> | 14249.3 |
| 60W | 123mm | 5 | <b>142.69</b> | 14269.1 |

Mini-globe  
Mini-Globe  
miniglobe  
Miniglobe  
Miniglobe

**E27****ø60mm***givré satin, satin kroko-ice, craquelé satijn, kraklè satinato, Krokoeis satin*

|     |      |   |               |         |
|-----|------|---|---------------|---------|
| 40W | 86mm | 6 | <b>149.49</b> | 14949.2 |
| 60W | 86mm | 6 | <b>149.69</b> | 14969.0 |

**E14****ø60mm***givré satin, satin kroko-ice, craquelé satijn, kraklè satinato, Krokoeis satin*

|     |      |   |               |         |
|-----|------|---|---------------|---------|
| 25W | 91mm | 6 | <b>143.29</b> | 14329.2 |
| 40W | 91mm | 6 | <b>143.49</b> | 14349.0 |

**E14****ø50mm***givré satin, satin kroko-ice, craquelé satijn, kraklè satinato, Krokoeis satin*

|     |      |   |               |         |
|-----|------|---|---------------|---------|
| 25W | 80mm | 8 | <b>144.29</b> | 14429.9 |
| 40W | 80mm | 8 | <b>144.49</b> | 14449.7 |





Globe  
Globe  
Globe  
Globe  
Globe



**E27** **ø95mm**

*ambré lustré, gold lustre, goud craquelé, interno dorato, gold gelüstert*

|     |       |   |               |         |
|-----|-------|---|---------------|---------|
| 40W | 138mm | 4 | <b>191.47</b> | 19147.7 |
| 60W | 138mm | 4 | <b>191.67</b> | 19167.5 |



**E27** **ø80mm**

*ambré lustré, gold lustre, goud craquelé, interno dorato, gold gelüstert*

|     |       |   |               |         |
|-----|-------|---|---------------|---------|
| 60W | 123mm | 5 | <b>192.67</b> | 19267.2 |
|-----|-------|---|---------------|---------|

Mini-globe  
Mini-Globe  
miniglobe  
Miniglobe  
Miniglobe



**E27** **ø60mm**

*ambré lustré, gold lustre, goud craquelé, interno dorato, gold gelüstert*

|     |      |   |               |         |
|-----|------|---|---------------|---------|
| 40W | 86mm | 6 | <b>193.47</b> | 19347.1 |
| 60W | 86mm | 6 | <b>193.67</b> | 19367.9 |



**E14** **ø60mm**

*ambré lustré, gold lustre, goud craquelé, interno dorato, gold gelüstert*

|     |      |   |               |         |
|-----|------|---|---------------|---------|
| 25W | 91mm | 6 | <b>196.27</b> | 19627.4 |
| 40W | 91mm | 6 | <b>196.47</b> | 19647.2 |



**E14** **ø50mm**

*ambré lustré, gold lustre, goud craquelé, interno dorato, gold gelüstert*

|     |      |   |               |         |
|-----|------|---|---------------|---------|
| 25W | 80mm | 8 | <b>195.27</b> | 19527.7 |
| 40W | 80mm | 8 | <b>195.47</b> | 19547.5 |





## Globe

**E27****ø125mm***granité clair, ice-crystal clear, IJskristal helder, cristalli di ghiaccio chiaro, Eiskristall klar*

|      |       |   |               |         |
|------|-------|---|---------------|---------|
| 60W  | 180mm | 6 | <b>130.60</b> | 13060.5 |
| 100W | 180mm | 6 | <b>130.00</b> | 13000.1 |

**E27****ø95mm***granité clair, ice-crystal clear, IJskristal helder, cristalli di ghiaccio chiaro, Eiskristall klar*

|      |       |   |               |         |
|------|-------|---|---------------|---------|
| 40W  | 138mm | 4 | <b>131.40</b> | 13140.4 |
| 60W  | 138mm | 4 | <b>131.60</b> | 13160.2 |
| 100W | 138mm | 4 | <b>131.00</b> | 13100.8 |

**E27****ø80mm***granité clair, ice-crystal clear, IJskristal helder, cristalli di ghiaccio chiaro, Eiskristall klar*

|     |       |   |               |         |
|-----|-------|---|---------------|---------|
| 40W | 123mm | 5 | <b>132.40</b> | 13240.1 |
| 60W | 123mm | 5 | <b>132.60</b> | 13260.9 |

## Mini-globe/ Miniglobe

**E27****ø60mm***granité clair, ice-crystal clear, IJskristal helder, cristalli di ghiaccio chiaro, Eiskristall klar*

|     |      |   |               |         |
|-----|------|---|---------------|---------|
| 25W | 86mm | 6 | <b>133.20</b> | 13320.0 |
| 40W | 86mm | 6 | <b>133.40</b> | 13340.8 |
| 60W | 86mm | 6 | <b>133.60</b> | 13360.6 |

**E14****ø60mm***granité clair, ice-crystal clear, IJskristal helder, cristalli di ghiaccio chiaro, Eiskristall klar*

|     |      |   |               |         |
|-----|------|---|---------------|---------|
| 25W | 91mm | 6 | <b>136.20</b> | 13620.1 |
| 40W | 91mm | 6 | <b>136.40</b> | 13640.9 |
| 60W | 91mm | 6 | <b>136.60</b> | 13660.7 |

**E14****ø50mm***granité clair, ice-crystal clear, IJskristal helder, cristalli di ghiaccio chiaro, Eiskristall klar*

|     |      |   |               |         |
|-----|------|---|---------------|---------|
| 25W | 80mm | 8 | <b>135.20</b> | 13520.4 |
| 40W | 80mm | 8 | <b>135.40</b> | 13540.2 |

## Sphérique

## Ball Lamp

## kogellamp

## Lampadina a goccia

## Tropfenlampe

**E14****ø45mm***granité clair, ice-crystal clear, IJskristal helder, cristalli di ghiaccio chiaro, Eiskristall klar*

|     |      |   |               |         |
|-----|------|---|---------------|---------|
| 25W | 75mm | 8 | <b>134.20</b> | 13420.7 |
| 40W | 75mm | 8 | <b>134.40</b> | 13440.5 |



Globe  
Globe  
Globe  
Globe  
Globe

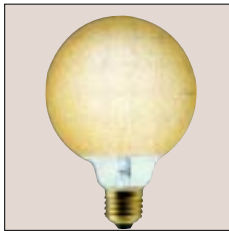

**E27** **ø125mm**

granité ambré, ice-crystal amber, IJskristal Bernstein, cristalli di ghiaccio ambrato, Eiskristall bernstein

|      |       |   |        |         |
|------|-------|---|--------|---------|
| 60W  | 180mm | 6 | 130.67 | 13067.4 |
| 100W | 180mm | 6 | 130.07 | 13007.0 |



**E27** **ø95mm**

granité ambré, ice-crystal amber, IJskristal Bernstein, cristalli di ghiaccio ambrato, Eiskristall bernstein

|      |       |   |        |         |
|------|-------|---|--------|---------|
| 40W  | 138mm | 4 | 131.47 | 13147.3 |
| 60W  | 138mm | 4 | 131.67 | 13167.1 |
| 100W | 138mm | 4 | 131.07 | 13107.7 |



**E27** **ø80mm**

granité ambré, ice-crystal amber, IJskristal Bernstein, cristalli di ghiaccio ambrato, Eiskristall bernstein

|     |       |   |        |         |
|-----|-------|---|--------|---------|
| 40W | 123mm | 5 | 132.47 | 13247.0 |
| 60W | 123mm | 5 | 132.67 | 13267.8 |

Mini-globe  
Mini-Globe  
miniglobe  
Miniglobe  
Miniglobe



**E27** **ø60mm**

granité ambré, ice-crystal amber, IJskristal Bernstein, cristalli di ghiaccio ambrato, Eiskristall bernstein

|     |      |   |        |         |
|-----|------|---|--------|---------|
| 25W | 86mm | 6 | 133.27 | 13327.9 |
| 40W | 86mm | 6 | 133.47 | 13347.7 |
| 60W | 86mm | 6 | 133.67 | 13367.5 |

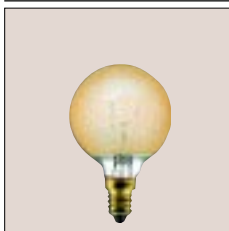

**E14** **ø60mm**

granité ambré, ice-crystal amber, IJskristal Bernstein, cristalli di ghiaccio ambrato, Eiskristall bernstein

|     |      |   |        |         |
|-----|------|---|--------|---------|
| 25W | 91mm | 6 | 136.27 | 13627.0 |
| 40W | 91mm | 6 | 136.47 | 13647.8 |

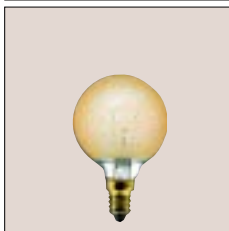

**E14** **ø50mm**

granité ambré, ice-crystal amber, IJskristal Bernstein, cristalli di ghiaccio ambrato, Eiskristall bernstein

|     |      |   |        |         |
|-----|------|---|--------|---------|
| 25W | 80mm | 8 | 135.27 | 13527.3 |
| 40W | 80mm | 8 | 135.47 | 13547.1 |



Globe  
Globe  
Globe  
Globe  
Globe

**E27****ø125mm***calotte dorée, crown mirror silver, kop-spiegel zilver, testina a specchio argentato, Kopfspiegel silber*

60W

180mm

1

**150.60**

15060.3

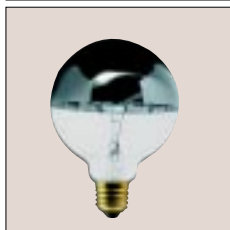
**E27****ø95mm***calotte dorée, crown mirror silver, kop-spiegel zilver, testina a specchio argentato, Kopfspiegel silber*

60W

138mm

1

**151.60**

15160.0

**E27****ø95mm***calotte argentée, crown mirror gold, kop-spiegel goud, testina a specchio dorato, Kopfspiegel gold*

60W

138mm

1

**151.67**

15167.9

**E27****ø125mm***anneau doré, semi-crown silver, ring-spiegel zilver, cerchio a specchio argentato, Ringspiegel silber*

60W

180mm

1

**153.60**

15360.4

**E27****ø95mm***anneau doré, semi-crown silver, ring-spiegel zilver, cerchio a specchio argentato, Ringspiegel silber*

60W

138mm

1

**154.60**

15460.1

**E27****ø95mm***anneau argenté, semi-crown gold, ring-spiegel goud, cerchio a specchio dorato, Ringspiegel gold*

60W

138mm

1

**154.67**

15467.0





**Standard**  
**GLS**  
**AGL**  
**LIC**  
**AGL**



**E27** **ø60mm**

*calotte dorée, crown mirror silver, kop-spiegel silver, testina a specchio argentato, Kopfspiegel silver*

|      |       |   |               |         |
|------|-------|---|---------------|---------|
| 40W  | 105mm | 6 | <b>301.40</b> | 30140.1 |
| 60W  | 105mm | 6 | <b>301.60</b> | 30160.9 |
| 100W | 123mm | 6 | <b>301.00</b> | 30100.5 |



**E27** **ø60mm**

*calotte argentée, crown mirror gold, kop-spiegel goud, testina a specchio dorato, Kopfspiegel gold*

|      |       |   |               |         |
|------|-------|---|---------------|---------|
| 40W  | 105mm | 6 | <b>303.40</b> | 30340.5 |
| 60W  | 105mm | 6 | <b>303.60</b> | 30360.3 |
| 100W | 123mm | 6 | <b>303.00</b> | 30300.9 |

**Sphérique**  
**Ball Lamp**  
**kogellamp**  
**Lampadina a goccia**  
**Tropfenlampe**



**E14** **ø45mm**

*calotte dorée, crown mirror silver, kop-spiegel silver, testina a specchio argentato, Kopfspiegel silver*

|     |      |   |               |         |
|-----|------|---|---------------|---------|
| 25W | 75mm | 8 | <b>300.20</b> | 30020.6 |
| 40W | 75mm | 8 | <b>300.40</b> | 30040.4 |



**E14** **ø45mm**

*calotte argentée, crown mirror gold, kop-spiegel goud, testina a specchio dorato, Kopfspiegel gold*

|     |      |   |               |         |
|-----|------|---|---------------|---------|
| 25W | 75mm | 8 | <b>302.20</b> | 30220.0 |
| 40W | 75mm | 8 | <b>302.40</b> | 30240.8 |





**Sphérique**  
**Ball Lamp**  
**kogellamp**  
**Lampadina a goccia**  
**Tropfenlampe**

**E14****ø45mm****ECO***dépoli, matt, mat, interno opaco, imatt*

|       |      |    |        |         |
|-------|------|----|--------|---------|
| 2x25W | 75mm | 50 | 127.22 | 12722.3 |
| 2x40W | 75mm | 50 | 127.42 | 12742.1 |

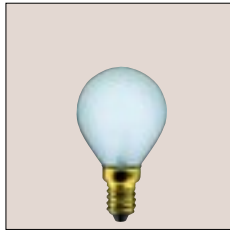
**E14****ø45mm***dépoli, matt, mat, interno opaco, imatt*

|     |      |   |        |         |
|-----|------|---|--------|---------|
| 8W  | 75mm | 8 | 127.08 | 12708.7 |
| 15W | 75mm | 8 | 127.10 | 12710.0 |
| 25W | 75mm | 8 | 127.20 | 12720.9 |
| 40W | 75mm | 8 | 127.40 | 12740.7 |
| 60W | 75mm | 8 | 127.60 | 12760.5 |

**E27****ø45mm***dépoli, matt, mat, interno opaco, imatt*

|     |      |   |        |         |
|-----|------|---|--------|---------|
| 8W  | 70mm | 8 | 128.08 | 12808.4 |
| 15W | 70mm | 8 | 128.10 | 12810.7 |
| 25W | 70mm | 8 | 128.20 | 12820.6 |
| 40W | 70mm | 8 | 128.40 | 12840.4 |
| 60W | 70mm | 8 | 128.60 | 12860.2 |

**E14****ø45mm****ECO***clair, clear, helder, chiaro, klar*

|       |      |    |        |         |
|-------|------|----|--------|---------|
| 2x25W | 75mm | 50 | 117.22 | 11722.4 |
| 2x40W | 75mm | 50 | 117.42 | 11742.2 |

**E14****ø45mm***clair, clear, helder, chiaro, klar*

|     |      |   |        |         |
|-----|------|---|--------|---------|
| 15W | 75mm | 8 | 117.10 | 11710.1 |
| 25W | 75mm | 8 | 117.20 | 11720.0 |
| 40W | 75mm | 8 | 117.40 | 11740.8 |
| 60W | 75mm | 8 | 117.60 | 11760.6 |

**E27****ø45mm***clair, clear, helder, chiaro, klar*

|     |      |   |        |         |
|-----|------|---|--------|---------|
| 15W | 70mm | 8 | 118.10 | 11810.8 |
| 25W | 70mm | 8 | 118.20 | 11820.7 |
| 40W | 70mm | 8 | 118.40 | 11840.5 |
| 60W | 70mm | 8 | 118.60 | 11860.3 |





**Sphérique**  
**Ball Lamp**  
**kogellamp**  
**Lampadina a goccia**  
**Tropfenlampe**

*Soft Opal*



**E14** **ø45mm**

*soft-opale, soft opal, softopaal, opale tenue, softopal*

|     |      |   |        |         |
|-----|------|---|--------|---------|
| 15W | 75mm | 8 | 432.10 | 43210.5 |
| 25W | 75mm | 8 | 432.20 | 43220.4 |
| 40W | 75mm | 8 | 432.40 | 43240.2 |
| 60W | 75mm | 8 | 432.60 | 43260.0 |



**E27** **ø45mm**

*soft-opale, soft opal, softopaal, opale tenue, softopal*

|     |      |   |        |         |
|-----|------|---|--------|---------|
| 25W | 70mm | 8 | 104.20 | 10420.0 |
| 40W | 70mm | 8 | 104.40 | 10440.8 |
| 60W | 70mm | 8 | 104.60 | 10460.6 |

**Sphérique Krypton**  
**Krypton Ball Lamp**  
**kogellamp Krypton**  
**Lampada di cripto a goccia**  
**Tropfenlampe Krypton**

**Krypton**  
**+10%**

*Soft Opal*



**E14** **ø45mm**

*krypton soft-opale, krypton soft opal, Krypton softopaal, cripto opale tenue, Krypton softopal*

|     |      |   |        |         |
|-----|------|---|--------|---------|
| 25W | 75mm | 8 | 432.21 | 43221.1 |
| 40W | 75mm | 8 | 432.41 | 43241.9 |
| 60W | 75mm | 8 | 432.61 | 43261.7 |



**E27** **ø45mm**

*krypton soft-opale, krypton soft opal, Krypton softopaal, cripto opale tenue, Krypton softopal*

|     |      |   |        |         |
|-----|------|---|--------|---------|
| 25W | 70mm | 8 | 104.21 | 10421.7 |
| 40W | 70mm | 8 | 104.41 | 10441.5 |
| 60W | 70mm | 8 | 104.61 | 10461.3 |





**Sphérique**  
**Ball Lamp**  
**kogellamp**  
**Lampadina a goccia**  
**Tropfenlampe**

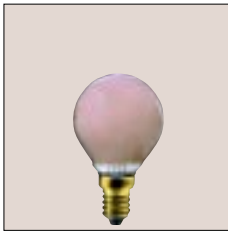

**E14** **ø45mm**  
*flammé, flame, flame, fiammingo, flame*

|     |      |   |        |         |
|-----|------|---|--------|---------|
| 25W | 75mm | 8 | 412.20 | 41220.6 |
| 40W | 75mm | 8 | 412.40 | 41240.4 |



**E14** **ø45mm**  
*givré doré, gold kroko-ice, craquelé goud, kraklè dorato, Krokoeis gold*

|     |      |   |        |         |
|-----|------|---|--------|---------|
| 25W | 75mm | 8 | 145.20 | 14520.3 |
| 40W | 75mm | 8 | 145.40 | 14540.1 |



**E14** **ø45mm**  
*granité clair, ice-crystal clear, IJskristal helder, cristalli di ghiaccio chiaro, Eiskristall klar*

|     |      |   |        |         |
|-----|------|---|--------|---------|
| 25W | 75mm | 8 | 134.20 | 13420.7 |
| 40W | 75mm | 8 | 134.40 | 13440.5 |

**Cosyball**  
**Cosyball**  
**Cosyball**  
**Cosyball**  
**Cosyball**



**E14** **ø45mm**  
*satin, satin, satijn, satinato, satin*

|     |       |   |        |         |
|-----|-------|---|--------|---------|
| 25W | 100mm | 8 | 516.20 | 51620.1 |
| 40W | 100mm | 8 | 516.40 | 51640.9 |



**E14** **ø45mm**  
*soft-opale, soft opal, softopaal, opale tenue, softopal*

|     |       |   |        |         |
|-----|-------|---|--------|---------|
| 25W | 100mm | 8 | 516.21 | 51621.8 |
| 40W | 100mm | 8 | 516.41 | 51641.6 |

*Soft Opal*





**Flamme**  
**Candle Lamp**  
**kaarslamp**  
**Lampadina a candela**  
**Kerzenlampe**



**E14** **ø35mm**

dépoli, matt, mat, interno opaco, imatt

**ECO**

|       |      |    |        |         |
|-------|------|----|--------|---------|
| 2x25W | 97mm | 50 | 449.22 | 44922.6 |
| 2x40W | 97mm | 50 | 449.42 | 44942.4 |



**E14** **ø35mm**

dépoli, matt, mat, interno opaco, imatt

|     |      |    |        |         |
|-----|------|----|--------|---------|
| 8W  | 97mm | 10 | 449.08 | 44908.0 |
| 15W | 97mm | 10 | 449.10 | 44910.3 |
| 25W | 97mm | 10 | 449.20 | 44920.2 |
| 40W | 97mm | 10 | 449.40 | 44940.0 |
| 60W | 97mm | 10 | 449.60 | 44960.8 |



**E27** **ø35mm**

dépoli, matt, mat, interno opaco, imatt

|     |      |    |        |         |
|-----|------|----|--------|---------|
| 8W  | 95mm | 10 | 444.08 | 44408.5 |
| 25W | 95mm | 10 | 444.20 | 44420.7 |
| 40W | 95mm | 10 | 444.40 | 44440.5 |
| 60W | 95mm | 10 | 444.60 | 44460.3 |



**E14** **ø35mm**

clair, clear, helder, chiaro, klar

**ECO**

|       |      |    |        |         |
|-------|------|----|--------|---------|
| 2x25W | 97mm | 50 | 448.22 | 44822.9 |
| 2x40W | 97mm | 50 | 448.42 | 44842.7 |



**E14** **ø35mm**

clair, clear, helder, chiaro, klar

|     |      |    |        |         |
|-----|------|----|--------|---------|
| 15W | 97mm | 10 | 448.10 | 44810.6 |
| 25W | 97mm | 10 | 448.20 | 44820.5 |
| 40W | 97mm | 10 | 448.40 | 44860.1 |



**E27** **ø35mm**

clair, clear, helder, chiaro, klar

|     |      |    |        |         |
|-----|------|----|--------|---------|
| 25W | 95mm | 10 | 443.20 | 44320.0 |
| 40W | 95mm | 10 | 443.40 | 44340.8 |
| 60W | 95mm | 10 | 443.60 | 44360.6 |

**Flamme Rustika**  
**Rustika Candle Lamps**  
**kaarslamp Rustika**  
**Lampadina a candela Rustika**  
**Rustika Kerzenlampe**



**E14** **ø35mm**

clair, clear, helder, chiaro, klar

|     |       |    |        |         |
|-----|-------|----|--------|---------|
| 25W | 101mm | 10 | 551.20 | 55120.2 |
| 40W | 101mm | 10 | 551.40 | 55140.0 |



**Flamme Krypton**  
**Candle Lamp Krypton**  
**kaarslamp Krypton**  
**Lampadina a candela Krypton**  
**Kerzenlampe Krypton**

**Krypton**  
 +10%  
*Soft Opal*



**E14** **ø35mm**

*krypton soft-opale, krypton soft opal, Krypton softopaal, cripto opale tenue, Krypton softopal*

|     |      |    |               |         |
|-----|------|----|---------------|---------|
| 25W | 97mm | 10 | <b>431.21</b> | 43121.4 |
| 40W | 97mm | 10 | <b>431.41</b> | 43141.2 |
| 60W | 97mm | 10 | <b>431.61</b> | 43161.0 |

**Flamme**  
**Candle Lamp**  
**kaarslamp**  
**Lampadina a candela**  
**Kerzenlampe**

*Soft Opal*



**E14** **ø35mm**

*soft-opale, soft opal, softopaal, opale tenue, softopal*

|     |      |    |               |         |
|-----|------|----|---------------|---------|
| 25W | 97mm | 10 | <b>431.20</b> | 43120.7 |
| 40W | 97mm | 10 | <b>431.40</b> | 43140.5 |
| 60W | 97mm | 10 | <b>431.60</b> | 43160.3 |



**E14** **ø35mm**

*cire, wax, wax, cerato, wachs*

|     |      |    |               |         |
|-----|------|----|---------------|---------|
| 25W | 97mm | 10 | <b>408.20</b> | 40820.9 |
| 40W | 97mm | 10 | <b>408.40</b> | 40840.7 |



**E14** **ø35mm**

*flammé, flame, flame, fiammingo, flame*

|     |      |    |               |         |
|-----|------|----|---------------|---------|
| 25W | 97mm | 10 | <b>411.20</b> | 41120.9 |
| 40W | 97mm | 10 | <b>411.40</b> | 41140.7 |



**E14** **ø35mm**

*givré clair, clear kroko-ice, craquelé helder, kraklè chiaro, Krokoeis klar*

|     |      |    |               |         |
|-----|------|----|---------------|---------|
| 25W | 97mm | 10 | <b>562.21</b> | 56221.5 |
| 40W | 97mm | 10 | <b>562.41</b> | 56241.3 |



**E14** **ø35mm**

*givré doré, gold kroko-ice, craquelé goud, kraklè dorato, Krokoeis gold*

|     |      |    |               |         |
|-----|------|----|---------------|---------|
| 25W | 97mm | 10 | <b>562.20</b> | 56220.8 |
| 40W | 97mm | 10 | <b>562.40</b> | 56240.6 |



**E14** **ø35mm**

*givré satin, satin kroko-ice, craquelé satijn, kraklè satinato, Krokoeis satin*

|     |      |    |               |         |
|-----|------|----|---------------|---------|
| 25W | 97mm | 10 | <b>562.29</b> | 56229.1 |
| 40W | 97mm | 10 | <b>562.49</b> | 56249.9 |



**Flamme**  
**Candle Lamp**  
**kaarslamp**  
**Lampadina a candela**  
**Kerzenlampe**



**E14** **ø35mm**

*ambré lustré, gold lustre, goud craquelé, interno dorato, gold gelüstert*

|     |      |    |               |         |
|-----|------|----|---------------|---------|
| 25W | 97mm | 10 | <b>491.20</b> | 49120.1 |
| 40W | 97mm | 10 | <b>491.40</b> | 49140.9 |



**E14** **ø35mm**

*granité clair, ice-crystal clear, IJskristal helder, cristalli di ghiaccio chiaro, Eiskristall klar*

|     |      |    |               |         |
|-----|------|----|---------------|---------|
| 25W | 97mm | 10 | <b>560.20</b> | 56020.4 |
| 40W | 97mm | 10 | <b>560.40</b> | 56040.2 |



**E14** **ø35mm**

*granité ambré, ice-crystal amber, IJskristal Bernstein, cristalli di ghiaccio ambrato, Eiskristall bernstein*

|     |      |    |               |         |
|-----|------|----|---------------|---------|
| 25W | 97mm | 10 | <b>561.27</b> | 56127.0 |
| 40W | 97mm | 10 | <b>561.47</b> | 56147.8 |

**Flamme effilée**  
**Candle Lamp Spitz**  
**tipkaarslamp**  
**Lampadina a candela a punta**  
**Kerzenlampe spitz**



**E14** **ø35mm**

*satin, satin, satijn, satinato, satin*

|     |       |    |               |         |
|-----|-------|----|---------------|---------|
| 25W | 110mm | 10 | <b>512.20</b> | 51220.3 |
| 40W | 110mm | 10 | <b>512.40</b> | 51240.1 |





**Flamme coup de vent**  
**Windswept Candle**  
**windstootkaars**  
**Lampadina a candela ad effetto colpo di vento**  
**Windstoßkerze**



**E14** **ø35mm**

*clair, clear, helder, chiaro, klar*

|     |       |    |        |         |
|-----|-------|----|--------|---------|
| 25W | 110mm | 10 | 510.21 | 51021.6 |
| 40W | 110mm | 10 | 510.41 | 51041.4 |



**E14** **ø35mm**

*satin, satin, satijn, satinato, satin*

|     |       |    |        |         |
|-----|-------|----|--------|---------|
| 25W | 110mm | 10 | 510.20 | 51020.9 |
| 40W | 110mm | 10 | 510.40 | 51040.7 |



**E14** **ø35mm**

*ambré lustré, gold lustre, goud craquelé, interno dorato, gold gelüstert*

|     |       |    |        |         |
|-----|-------|----|--------|---------|
| 25W | 110mm | 10 | 510.27 | 51027.8 |
| 40W | 110mm | 10 | 510.47 | 51047.6 |

**Flamme Cosylight**  
**Candle Lamp Cosylight**  
**kaarslamp Cosylight**  
**Lampadina a candela Cosylight**  
**Kerzenlampe Cosylight**



**E14** **ø35mm**

*clair, clear, helder, chiaro, klar*

|     |       |    |        |         |
|-----|-------|----|--------|---------|
| 25W | 130mm | 10 | 513.20 | 51320.0 |
| 40W | 130mm | 10 | 513.40 | 51340.8 |



**E14** **ø35mm**

*satin, satin, satijn, satinato, satin*

|     |       |    |        |         |
|-----|-------|----|--------|---------|
| 15W | 130mm | 10 | 514.10 | 51410.8 |
| 25W | 130mm | 10 | 514.20 | 51420.7 |
| 40W | 130mm | 10 | 514.40 | 51440.5 |
| 60W | 130mm | 10 | 514.60 | 51460.3 |



**E14** **ø35mm**

*ambré lustré, gold lustre, goud craquelé, interno dorato, gold gelüstert*

|     |       |    |        |         |
|-----|-------|----|--------|---------|
| 25W | 130mm | 10 | 513.27 | 51327.9 |
| 40W | 130mm | 10 | 513.47 | 51347.7 |





**Flamme torsadée**  
**Candle Lamp Twisted**  
**gedraaide kaarslamp**  
**Lampadina a candela tortiglione**  
**Kerzenlampe gedreht**



**E14** **ø35mm**  
*dépoli, matt, mat, interno opaco, imatt*

|     |      |    |        |         |
|-----|------|----|--------|---------|
| 25W | 97mm | 10 | 451.20 | 45120.5 |
| 40W | 97mm | 10 | 451.40 | 45140.3 |
| 60W | 97mm | 10 | 451.60 | 45160.1 |



**E14** **ø35mm**  
*clair, clear, helder, chiaro, klar*

|     |      |    |        |         |
|-----|------|----|--------|---------|
| 25W | 97mm | 10 | 450.20 | 45020.8 |
| 40W | 97mm | 10 | 450.40 | 45040.6 |
| 60W | 97mm | 10 | 450.60 | 45060.4 |

**Flamme torsadée Krypton**  
**Candle Lamp Twisted Krypton**  
**kaarslamp Krypton gedraaid**  
**Lampadina di cripto a candela**  
**Kerzenlampe Krypton gedreht**

**Krypton**  
+10% *Soft Opal*



**E14** **ø35mm**  
*soft-opale, soft opal, softopaal, opale tenue, softopal*

|     |      |    |        |         |
|-----|------|----|--------|---------|
| 25W | 97mm | 10 | 431.22 | 43122.1 |
| 40W | 97mm | 10 | 431.42 | 43142.9 |
| 60W | 97mm | 10 | 431.62 | 43162.7 |

**Flamme torsadée Rustika**  
**Rustika Twisted Candle Lamps**  
**gedraaide kaarslamp Rustika**  
**Lampadina a candela Rustika, tortiglione**  
**Rustika Kerzenlampe gedreht**

**Rustika®**



**E14** **ø35mm**  
*clair, clear, helder, chiaro, klar*

|     |       |    |        |         |
|-----|-------|----|--------|---------|
| 25W | 101mm | 10 | 552.20 | 55220.9 |
| 40W | 101mm | 10 | 552.40 | 55240.7 |

**Flamme torsadée**  
**Candle Lamp Twisted**  
**gedraaide kaarslamp**  
**Lampadina a candela tortiglione**  
**Kerzenlampe gedreht**



**E14** **ø35mm**  
*ambré lustré, gold lustre, goud craquelé, interno dorato, gold gelüstert*

|     |      |    |        |         |
|-----|------|----|--------|---------|
| 25W | 97mm | 10 | 452.20 | 45220.2 |
| 40W | 97mm | 10 | 452.40 | 45240.0 |



**Flamme Royal torsadée**  
**Candle Lamp Royal Twisted**  
**gedraaide kaarslamp Royal**  
**Lampadina a candela Royal tortiglione**  
**Kerzenlampe Royal gedreht**



**E14** **ø34mm**

*clair, clear, helder, chiaro, klar*

|     |       |    |        |         |
|-----|-------|----|--------|---------|
| 25W | 117mm | 10 | 565.20 | 56520.9 |
| 40W | 117mm | 10 | 565.40 | 56540.7 |



**E14** **ø34mm**

*satın, satin, satijn, satinato, satin*

|     |       |    |        |         |
|-----|-------|----|--------|---------|
| 25W | 117mm | 10 | 565.21 | 56521.6 |
| 40W | 117mm | 10 | 565.41 | 56541.4 |
| 60W | 117mm | 10 | 565.61 | 56561.2 |



**E14** **ø34mm**

*doré, gold, goud, dorato, gold*

|     |       |    |        |         |
|-----|-------|----|--------|---------|
| 25W | 117mm | 10 | 565.27 | 56527.8 |
| 40W | 117mm | 10 | 565.47 | 56547.6 |
| 60W | 117mm | 10 | 565.67 | 56567.4 |

**Flamme torsadée géante mince**  
**Giant Twisted Narrow Candle**  
**slanke gedraaide reuzenkaars**  
**Lampada gigante a candela, tortiglione e sottile**  
**Riesenkerzenlampe gedreht schlank**



**E14** **ø41mm**

*satın, satin, satijn, satinato, satin*

|     |       |   |        |         |
|-----|-------|---|--------|---------|
| 40W | 125mm | 8 | 453.40 | 45340.7 |
| 60W | 125mm | 8 | 453.60 | 45360.5 |



**E14** **ø41mm**

*ambré lustré, gold lustre, goud craquelé, interno dorato, gold gelüstert*

|     |       |   |        |         |
|-----|-------|---|--------|---------|
| 40W | 125mm | 8 | 453.47 | 45347.6 |
|-----|-------|---|--------|---------|

**Flamme torsadée géante**  
**Giant Twisted Candle**  
**gedraaide reuzenkaars**  
**Lampadina gigante a candela, tortiglione**  
**Riesenkerzenlampe gedreht**



**E14** **ø50mm**

*satın, satin, satijn, satinato, satin*

|     |       |   |        |         |
|-----|-------|---|--------|---------|
| 60W | 140mm | 6 | 740.66 | 74066.8 |
|-----|-------|---|--------|---------|

**E27** **ø50mm**

*satın, satin, satijn, satinato, satin*

|     |       |   |        |         |
|-----|-------|---|--------|---------|
| 60W | 140mm | 6 | 740.65 | 74065.1 |
|-----|-------|---|--------|---------|



**Flamme Flambeau**  
**Candle Lamp Flambeau**  
**kaarslamp Flambeau**  
**Lampadina a candela Flambeau**  
**Kerzenlampe Flambeau**



**E14** **ø50mm**

*satín, satin, satijn, satinato, satin*

25W 115mm

8

521.20

52120.5

40W 115mm

8

521.40

52140.3



**E27** **ø50mm**

*satín, satin, satijn, satinato, satin*

40W 111mm

8

523.40

52340.7

**Flamme Gréco**  
**Greco Candle Lamp**  
**Kaarslamp Greco**  
**Lampadina a candela Greco**  
**Kerzenlampe Greco**



**E14** **ø33mm**

*clair, clear, helder, chiaro, klar*

25W 115mm

10

563.29

56329.8

40W 115mm

10

563.49

56349.6

60W 115mm

10

563.69

56369.4

**Bougie à flamme oscillante**  
**Feelings Flame Candle**  
**Feelings Flame - kaars**  
**Lampadina a candela Feelings Flame**  
**Feelings Flame Kerzenlampe**



**E14** **ø26mm**

*blanc, white, wit, bianco, weiß*

3W 140mm

1

533.00

53300.0





Globe Double-life  
 Globe Double-life  
 Globe Double-life  
 Globe Double-life  
 Globe Double-life



**E27** **ø60mm**  
 soft-opale, soft opal, softopaal, opale tenue, softopal

*Soft Opal*

|      |      |    |        |         |
|------|------|----|--------|---------|
| 25W  | 86mm | 12 | 103.21 | 10321.0 |
| 40W  | 86mm | 12 | 103.41 | 10341.8 |
| 60W  | 86mm | 12 | 103.61 | 10361.6 |
| 100W | 86mm | 12 | 103.01 | 10301.2 |



**E27** **ø60mm**  
 clair, clear, helder, chiaro, klar

|      |      |    |        |         |
|------|------|----|--------|---------|
| 25W  | 86mm | 12 | 113.20 | 11320.2 |
| 40W  | 86mm | 12 | 113.40 | 11340.0 |
| 60W  | 86mm | 12 | 113.60 | 11360.8 |
| 100W | 86mm | 12 | 113.00 | 11300.4 |



**E27** **ø60mm**  
 dépoli, matt, mat, interno opaco, imatt

|      |      |    |        |         |
|------|------|----|--------|---------|
| 25W  | 86mm | 12 | 123.22 | 12322.5 |
| 40W  | 86mm | 12 | 123.42 | 12342.3 |
| 60W  | 86mm | 12 | 123.62 | 12362.1 |
| 100W | 86mm | 12 | 123.02 | 12302.7 |

1000 h = 2000 h

Double life

Double life

Double life



Krypton  
Krypton  
Krypton  
Cripto  
Krypton

**Krypton**



**E27** **ø50mm**

soft-opale, soft opal, softopaal, opale tenue, softopal

|     |      |   |        |         |
|-----|------|---|--------|---------|
| 40W | 90mm | 8 | 433.40 | 43340.9 |
| 60W | 90mm | 8 | 433.60 | 43360.7 |

**Krypton**  
Soft Opal



**E27** **ø60mm**

soft-opale, soft opal, softopaal, opale tenue, softopal

|      |      |   |        |         |
|------|------|---|--------|---------|
| 75W  | 95mm | 6 | 433.70 | 43370.6 |
| 100W | 95mm | 6 | 433.00 | 43300.3 |

**Krypton**  
Soft Opal



**E27** **ø50mm**

dépoli, matt, mat, interno opaco, imatt

|     |      |   |        |         |
|-----|------|---|--------|---------|
| 40W | 90mm | 8 | 433.42 | 43342.3 |
| 60W | 90mm | 8 | 433.62 | 43362.1 |

**Krypton**



**E27** **ø60mm**

dépoli, matt, mat, interno opaco, imatt

|      |      |   |        |         |
|------|------|---|--------|---------|
| 75W  | 95mm | 6 | 433.72 | 43372.0 |
| 100W | 95mm | 6 | 433.02 | 43302.7 |

**Krypton**

**+10%** **+10%**

**Soft Opal**

**Krypton**



**Standard**  
**GLS**  
**AGL**  
**LIC**  
**AGL**

**E27****ø60mm****ECO***dépoli, matt, mat, interno opaco, imatt*

|        |       |    |               |         |
|--------|-------|----|---------------|---------|
| 2x25W  | 105mm | 50 | <b>419.22</b> | 41922.9 |
| 2x40W  | 105mm | 50 | <b>419.42</b> | 41942.7 |
| 2x60W  | 105mm | 50 | <b>419.62</b> | 41962.5 |
| 2x100W | 105mm | 50 | <b>419.02</b> | 41902.1 |

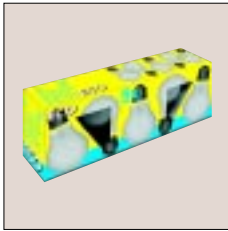
**E27****ø60mm****ECO***dépoli, matt, mat, interno opaco, imatt*

|       |       |    |               |         |
|-------|-------|----|---------------|---------|
| 5x40W | 105mm | 16 | <b>419.45</b> | 41945.8 |
| 5x60W | 105mm | 16 | <b>419.65</b> | 41965.6 |

**E27****ø60mm***dépoli, matt, mat, interno opaco, imatt*

|      |       |       |               |                |         |
|------|-------|-------|---------------|----------------|---------|
| 15W  | 105mm | 21    | <b>419.10</b> | 41910.6        |         |
| 25W  | 105mm | 21    | <b>419.20</b> | 41920.5        |         |
| 40W  | 105mm | 21    | <b>419.40</b> | 41940.3        |         |
| 60W  | 105mm | 21    | <b>419.60</b> | 41960.1        |         |
| 75W  | 105mm | 21    | <b>419.70</b> | 41970.0        |         |
| 100W | 105mm | 21    | <b>419.00</b> | 41900.7        |         |
| 150W | 123mm | ø65mm | 20            | <b>419.150</b> | 41916.8 |
| 200W | 123mm | ø65mm | 20            | <b>419.200</b> | 41921.2 |

**E27****ø60mm****ECO***clair, clear, helder, chiaro, klar*

|        |       |    |               |         |
|--------|-------|----|---------------|---------|
| 2x25W  | 105mm | 50 | <b>418.22</b> | 41822.2 |
| 2x40W  | 105mm | 50 | <b>418.42</b> | 41842.0 |
| 2x60W  | 105mm | 50 | <b>418.62</b> | 41862.8 |
| 2x100W | 105mm | 50 | <b>418.02</b> | 41802.4 |

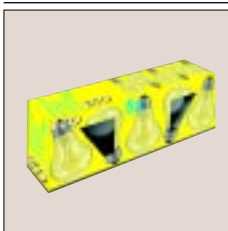
**E27****ø60mm****ECO***clair, clear, helder, chiaro, klar*

|       |       |    |               |         |
|-------|-------|----|---------------|---------|
| 5x40W | 105mm | 16 | <b>418.45</b> | 41845.1 |
| 5x60W | 105mm | 16 | <b>418.65</b> | 41865.9 |

**E27****ø60mm***clair, clear, helder, chiaro, klar*

|      |       |       |               |                |         |
|------|-------|-------|---------------|----------------|---------|
| 15W  | 105mm | 21    | <b>418.10</b> | 41810.9        |         |
| 25W  | 105mm | 21    | <b>418.20</b> | 41820.8        |         |
| 40W  | 105mm | 21    | <b>418.40</b> | 41840.6        |         |
| 60W  | 105mm | 21    | <b>418.60</b> | 41860.4        |         |
| 75W  | 105mm | 21    | <b>418.70</b> | 41870.3        |         |
| 100W | 105mm | 21    | <b>418.00</b> | 41800.0        |         |
| 150W | 123mm | ø65mm | 20            | <b>418.150</b> | 41816.1 |
| 200W | 123mm | ø65mm | 20            | <b>418.200</b> | 41821.5 |



Standard  
GLS  
AGL  
LIC  
AGL



**E27** **ø60mm**

*soft-opale, soft opal, softopaal, opale tenue, softopal*

*Soft Opal*

|      |       |   |        |         |
|------|-------|---|--------|---------|
| 25W  | 105mm | 6 | 430.20 | 43020.0 |
| 40W  | 105mm | 6 | 430.40 | 43040.8 |
| 60W  | 105mm | 6 | 430.60 | 43060.6 |
| 75W  | 105mm | 6 | 430.70 | 43070.5 |
| 100W | 105mm | 6 | 430.00 | 43000.2 |



**E27** **ø60mm**

*cire, wax, wax, cerato, wachs*

|     |       |   |        |         |
|-----|-------|---|--------|---------|
| 40W | 105mm | 6 | 407.40 | 40740.0 |
| 60W | 105mm | 6 | 407.60 | 40760.8 |



**E27** **ø60mm**

*flammé, flame, flame, fiammingo, flame*

|      |       |   |        |         |
|------|-------|---|--------|---------|
| 40W  | 105mm | 6 | 410.40 | 41040.0 |
| 60W  | 105mm | 6 | 410.60 | 41060.8 |
| 100W | 105mm | 6 | 410.00 | 41000.4 |



**E27** **ø60mm**

*lumière du jour, clair, day-light clear, daglicht helder, chiaro giorno, Tageslicht klar*

|      |       |   |        |         |
|------|-------|---|--------|---------|
| 60W  | 105mm | 6 | 470.60 | 47060.2 |
| 100W | 105mm | 6 | 470.00 | 47000.8 |

Rustika de Luxe  
Rustika de Luxe GLS  
normaallamp Rustika de Luxe  
Rustika de Luxe LIC  
Rustika de Luxe AGL

**Rustika®**



**E27** **ø60mm**

*clair, clear, helder, chiaro, klar*

|     |       |   |        |         |
|-----|-------|---|--------|---------|
| 40W | 110mm | 6 | 548.40 | 54840.0 |
| 60W | 110mm | 6 | 548.60 | 54860.8 |

Parinsecte  
Anti-insect  
Anti Insecta  
Anti Insecta  
Anti Insecta

Anti Insecta



**E27** **ø60mm**

*jeune spécial, Special yellow, geel, giallo speciale, spezial gelb*

|     |       |   |        |         |
|-----|-------|---|--------|---------|
| 40W | 105mm | 6 | 460.40 | 46040.5 |
| 60W | 105mm | 6 | 460.60 | 46060.3 |



*clair  
clear  
held  
chiaro  
klar*



*flammé  
flame  
flame  
fiammingo  
flame*



*cire  
wax  
wax  
cerato  
wachs*



*soft-opale  
soft opal  
softopaal  
opale tenue  
softopal*





**Rustika filament de carbone**  
**Rustika Carbon Filament Lamp**  
**kooldraadlamp Rustika**  
**Lampadina a filamento di carbone Rustika**  
**Rustika Kohlefadenlampe**



**Rustika®**



 **E27**    **ø60mm**

*clair, clear, helder, chiaro, klar*

60W

106mm

6

700.60

70060.0

**Rustika de Luxe**  
**Rustika de Luxe GLS**  
**normaallamp Rustika de Luxe**  
**Rustika de Luxe LIC**  
**Rustika de Luxe AGL**



**Rustika®**



 **E27**    **ø60mm**

*clair, clear, helder, chiaro, klar*

40W

110mm

6

548.40

54840.0

60W

110mm

6

548.60

54860.8





**Rustika filament multiple**  
**Rustika Multi-Filament**  
**meervoudig filament Rustika**  
**Lampadina con filamento a spirale multiplo Rustika**  
**Rustika Vielfachwendel**



**Rustika®**



 **E27**    **ø65mm**

*clair, clear, helder, chiaro, klar*

|     |       |   |        |         |
|-----|-------|---|--------|---------|
| 40W | 142mm | 1 | 550.40 | 55040.3 |
| 60W | 142mm | 1 | 550.60 | 55060.1 |

**Spirale Rustika**  
**Rustika Spiral**  
**Rustika spiraal**  
**Spirale Rustika**  
**Rustika Spirale**



**Rustika®**



 **E27**    **ø45mm**

*clair, clear, helder, chiaro, klar*

|     |       |   |        |         |
|-----|-------|---|--------|---------|
| 40W | 110mm | 8 | 555.40 | 55540.8 |
| 60W | 110mm | 8 | 555.60 | 55560.6 |

**Tube géant Rustika**  
**Rustika Tube Lamp**  
**Rustika buis groot**  
**Lampadina gigante tubolare Rustika**  
**Rustika Riesenröhrenlampe**



**Rustika®**



 **E27**    **ø45mm**

*clair, clear, helder, chiaro, klar*

|     |       |   |        |         |
|-----|-------|---|--------|---------|
| 40W | 110mm | 8 | 556.40 | 55640.5 |
| 60W | 110mm | 8 | 556.60 | 55660.3 |





**Flamme Rustika**  
**Rustika Candle Lamps**  
**kaarslamp Rustika**  
**Lampadina a candela Rustika**  
**Rustika Kerzenlampe**

**E14****ø35mm***clair, clear, helder, chiaro, klar*

25W 101mm

10

551.20

55120.2

40W 101mm

10

551.40

55140.0

**Flamme torsadée Rustika**  
**Rustika Twisted Candle Lamps**  
**gedraaide kaarslamp Rustika**  
**Lampadina a candela Rustika, tortiglione**  
**Rustika Kerzenlampe gedreht**

**E14****ø35mm***clair, clear, helder, chiaro, klar*

25W 101mm

10

552.20

55220.9

40W 101mm

10

552.40

55240.7

**Flamme torsadée géante Rustika**  
**Rustika Giant Twisted Candle**  
**Rustika gedraaide reuzenkaars**  
**Lampadina gigante a candela, tortiglione Rustika**  
**Rustika Riesenkerzenlampe gedreht**

**E27****ø45mm***clair, clear, helder, chiaro, klar*

40W 120mm

8

554.40

55440.1

60W 120mm

8

554.60

55460.9

**Cosylight Rustika**  
**Rustika Cosylight**  
**Rustika Cosylight**  
**Rustika Cosylight**  
**Rustika Cosylight**

**E14****ø35mm***clair, clear, helder, chiaro, klar*

25W 130mm

10

553.20

55320.6

40W 130mm

10

553.40

55340.4





**R50 Lampe réflecteur Akzent**  
**R50 Akzent reflector lamp**  
**R50 Akzent-reflectorlamp**  
**Riflettore Akzent R50**  
**R50 Akzent-Reflektorlampe**



**E14** **ø50mm**

*noir, black, zwart, nero, schwarz*

40W 86mm 35° 8 200.08 20008.7



**E14** **ø50mm**

*doré total, full gold, goud, totalmente dorato, vollgold*

40W 86mm 35° 8 200.05 20005.6



**E14** **ø50mm**

*chrome total, full chrome, chrom, totalmente cromato, vollchrom*

40W 86mm 35° 8 200.03 20003.2



**E14** **ø50mm**

*alu brossé, alu matt, alu mat, color alluminio opaco, alu matt*

40W 86mm 35° 8 200.01 20001.8

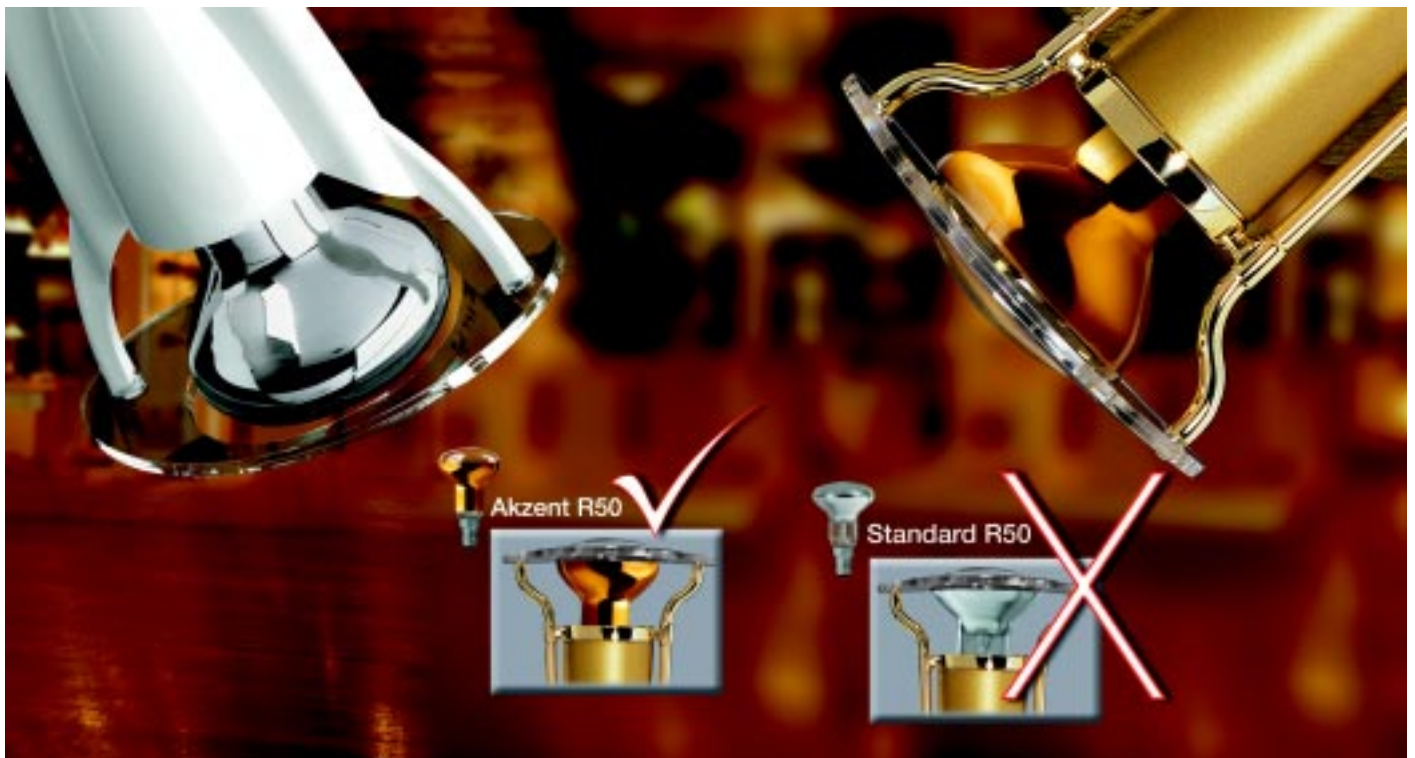

**R50 réflecteur Akzent Happy Color**  
**R50 Akzent Reflector Lamp Happy Color**  
**R50 Akzent reflectorlamp Happy Color**  
**Riflettore R50 Akzent Happy Color**  
**R50 Akzent-Reflektorlampe Happy Color**



**E14** **ø50mm**  
 rouge, red, rood, rosso, rot  
 40W 86mm 35° 8 200.07 20007.0



**E14** **ø50mm**  
 jaune, yellow, geel, giallo, gelb  
 40W 86mm 35° 8 200.04 20004.9



**E14** **ø50mm**  
 vert, green, groen, verde, grün  
 40W 86mm 35° 8 200.06 20006.3



**E14** **ø50mm**  
 bleu, blue, blauw, blu, blau  
 40W 86mm 35° 8 200.02 20002.5



**E14** **ø50mm**  
 clair, clear, helder, chiaro, klar  
 40W 86mm 35° 8 200.10 20010.0





**Réflecteur**  
**Reflector Lamp**  
**reflectorlamp**  
**Riflettore**  
**Reflektorlampe**



**E14** **ø39mm**  
argent, silver, zilver, argentato, silber

|     |      |     |    |               |         |
|-----|------|-----|----|---------------|---------|
| 30W | 66mm | 40° | 10 | <b>202.30</b> | 20230.2 |
|-----|------|-----|----|---------------|---------|

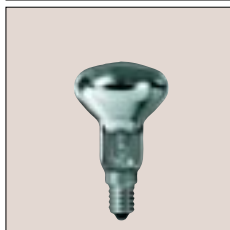

**E14** **ø50mm**  
argent, silver, zilver, argentato, silber

|     |      |     |    |               |         |
|-----|------|-----|----|---------------|---------|
| 25W | 86mm | 35° | 50 | <b>200.21</b> | 20021.6 |
|-----|------|-----|----|---------------|---------|

|     |      |     |    |               |         |
|-----|------|-----|----|---------------|---------|
| 40W | 86mm | 35° | 50 | <b>200.41</b> | 20041.4 |
|-----|------|-----|----|---------------|---------|

TIP



**E14** **ø50mm**  
argent, silver, zilver, argentato, silber

|       |      |     |    |               |         |
|-------|------|-----|----|---------------|---------|
| 2x25W | 86mm | 35° | 50 | <b>200.22</b> | 20022.3 |
|-------|------|-----|----|---------------|---------|

|       |      |     |    |               |         |
|-------|------|-----|----|---------------|---------|
| 2x40W | 86mm | 35° | 50 | <b>200.42</b> | 20042.1 |
|-------|------|-----|----|---------------|---------|

ECO



**E14** **ø50mm**  
argent, silver, zilver, argentato, silber

|       |      |     |   |               |         |
|-------|------|-----|---|---------------|---------|
| 5x40W | 86mm | 35° | 1 | <b>200.45</b> | 20045.2 |
|-------|------|-----|---|---------------|---------|

TIP



**E14** **ø50mm**  
argent, silver, zilver, argentato, silber

|     |      |     |   |               |         |
|-----|------|-----|---|---------------|---------|
| 25W | 86mm | 35° | 8 | <b>200.20</b> | 20020.9 |
|-----|------|-----|---|---------------|---------|

|     |      |     |   |               |         |
|-----|------|-----|---|---------------|---------|
| 40W | 86mm | 35° | 8 | <b>200.40</b> | 20040.7 |
|-----|------|-----|---|---------------|---------|

|     |      |     |   |               |         |
|-----|------|-----|---|---------------|---------|
| 60W | 86mm | 35° | 8 | <b>200.60</b> | 20060.5 |
|-----|------|-----|---|---------------|---------|



**E14** **ø50mm**  
argent, silver, zilver, argentato, silber

|     |      |          |   |               |         |
|-----|------|----------|---|---------------|---------|
| 25W | 86mm | spot 30° | 8 | <b>200.28</b> | 20028.5 |
|-----|------|----------|---|---------------|---------|

|     |      |          |   |               |         |
|-----|------|----------|---|---------------|---------|
| 40W | 86mm | spot 30° | 8 | <b>200.48</b> | 20048.3 |
|-----|------|----------|---|---------------|---------|

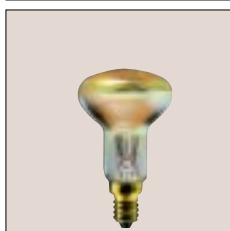

**E14** **ø50mm**  
doré, gold, goud, dorato, gold

|     |      |     |   |               |         |
|-----|------|-----|---|---------------|---------|
| 25W | 86mm | 35° | 8 | <b>207.20</b> | 20720.8 |
|-----|------|-----|---|---------------|---------|

|     |      |     |   |               |         |
|-----|------|-----|---|---------------|---------|
| 40W | 86mm | 35° | 8 | <b>207.40</b> | 20740.6 |
|-----|------|-----|---|---------------|---------|

|     |      |     |   |               |         |
|-----|------|-----|---|---------------|---------|
| 60W | 86mm | 35° | 8 | <b>207.60</b> | 20760.4 |
|-----|------|-----|---|---------------|---------|





**Réflecteur**  
**Reflector Lamp**  
**reflectorlamp**  
**Riflettore**  
**Reflektorlampe**



**E27** **ø63mm**

dépoli, matt, mat, opaco, matt

**ECO**

|       |       |     |    |        |         |
|-------|-------|-----|----|--------|---------|
| 2x40W | 103mm | 35° | 50 | 220.42 | 22042.9 |
| 2x60W | 103mm | 35° | 50 | 220.62 | 22062.7 |



**E27** **ø63mm**

argent, silver, zilver, argentato, silber

|     |       |     |   |        |         |
|-----|-------|-----|---|--------|---------|
| 25W | 103mm | 35° | 6 | 220.20 | 22020.7 |
| 40W | 103mm | 35° | 6 | 220.40 | 22040.5 |
| 60W | 103mm | 35° | 6 | 220.60 | 22060.3 |



**E27** **ø63mm**

argent, silver, zilver, argentato, silber

|     |       |          |   |        |         |
|-----|-------|----------|---|--------|---------|
| 40W | 105mm | spot 30° | 8 | 220.48 | 22048.1 |
| 60W | 105mm | spot 30° | 8 | 220.68 | 22068.9 |



**E27** **ø63mm**

doré, gold, goud, dorato, gold

|     |       |     |   |        |         |
|-----|-------|-----|---|--------|---------|
| 40W | 103mm | 35° | 6 | 227.40 | 22740.4 |
| 60W | 103mm | 35° | 6 | 227.60 | 22760.2 |



**E27** **ø80mm**

argent, silver, zilver, argentato, silber

|      |       |     |   |        |         |
|------|-------|-----|---|--------|---------|
| 25W  | 116mm | 80° | 5 | 240.20 | 24020.5 |
| 40W  | 116mm | 80° | 5 | 240.40 | 24040.3 |
| 60W  | 116mm | 80° | 5 | 240.60 | 24060.1 |
| 75W  | 116mm | 80° | 5 | 240.70 | 24070.0 |
| 100W | 116mm | 80° | 5 | 240.00 | 24000.7 |



**E27** **ø95mm**

argent, silver, zilver, argentato, silber

|      |       |     |   |        |         |
|------|-------|-----|---|--------|---------|
| 75W  | 134mm | 35° | 4 | 260.70 | 26070.8 |
| 100W | 134mm | 35° | 4 | 260.00 | 26000.5 |

**PAR38 réflecteur**  
**PAR 38 reflector lamp**  
**PAR38 reflectorlamp**  
**Riflettore PAR38**  
**PAR38 Reflektorlampe**



**E27** **ø122mm**

clair, clear, helder, chiaro, klar

|      |       |           |   |    |        |         |
|------|-------|-----------|---|----|--------|---------|
| 60W  | 136mm | flood 30° | ✓ | 10 | 270.60 | 27060.8 |
| 80W  | 136mm | flood 30° | ✓ | 10 | 270.80 | 27080.6 |
| 120W | 136mm | flood 30° | ✓ | 10 | 270.20 | 27020.2 |
| 80W  | 136mm | spot 12°  | ✓ | 10 | 271.80 |         |

27180.3





Suspension halogène pour plantes avec ampoule

Halogen Plant Light with Lamp

Halogeen plantenpendel met lamp

Lampada alogena a pendolo per piante con lampadina

Halogen Pflanzenleuchtenpendel mit Halogen-Pflanzenlampe PAR30 rosé

**E27****ø120mm***blanc, white, wit, bianco, weiß*

75W

170mm

30°

1

503.39

50339.3

Suspension pour plantes HQ professionnelle avec ampoule

HQ Professional plant-light with Lamp

HQ-Professional plantenpendel met lamp

Lampada da pendolo per piante HQ-Professional con lampadina

HQ-Professional Pflanzenleuchtenpendel mit HQ Pflanzenlampe

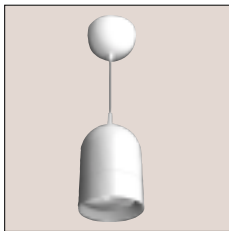
**E27****ø140mm****12.000h***blanc, white, wit, bianco, weiß*

80W

200mm

120°

1

503.34

50334.8

HQ-Lampe réflecteur à vapeur de mercure pour 503.34

HQ-Mercury Vapour Reflector Lamp for 503.34

HQ-reflectorlamper zilver voor 503.34

Riflettore HQ a vapori di mercurio per 503.34

HQ-Reflektorlampe Quecksilberdampf für 503.34

**E27****ø125mm****12.000h***argent, silver, zilver, argentato, silber*

80W

168mm

120°

6

503.80

50380.5

**PROFESSIONAL**  
**HQ-80W**

**Halogen PAR 30**

|        |       |           |
|--------|-------|-----------|
| 30 cm  | △ 30° | 18778 Lux |
| 50 cm  | △ 30° | 5760 Lux  |
| 80 cm  | △ 30° | 3641 Lux  |
| 130 cm | △ 30° | 1000 Lux  |
| 180 cm | △ 30° | 592 Lux   |



**Réflecteur pousse-plante**  
**Plant Growth Reflector Lamp**  
**plantengroei-reflectorlamp**  
**Riflettore per piante**  
**Reflektorlampe Pflanzenwachstum**

**E27****ø95mm***bleu, blue, blauw, blu, blau*

|      |       |     |   |        |         |
|------|-------|-----|---|--------|---------|
| 75W  | 134mm | 35° | 4 | 500.70 | 50070.5 |
| 100W | 134mm | 35° | 4 | 500.00 | 50000.2 |

**E27****ø80mm***bleu, blue, blauw, blu, blau*

|     |       |     |   |        |         |
|-----|-------|-----|---|--------|---------|
| 60W | 110mm | 80° | 5 | 501.60 | 50160.3 |
| 75W | 110mm | 80° | 5 | 501.70 | 50170.2 |

**E27****ø63mm***bleu, blue, blauw, blu, blau*

|     |       |     |   |        |         |
|-----|-------|-----|---|--------|---------|
| 40W | 103mm | 35° | 6 | 502.40 | 50240.2 |
| 60W | 103mm | 35° | 6 | 502.60 | 50260.0 |

**R80 Réflecteur Néodyme**  
**R80 Neodym Reflector Lamp**  
**R80 reflectorlamp Neodym**  
**Riflettore R80 Neodym**  
**R80 Reflektorlampe Neodym**

**E27****ø80mm***rosé, rosé, roze, rosato, rosé*

|     |       |     |   |        |         |
|-----|-------|-----|---|--------|---------|
| 60W | 110mm | 80° | 5 | 511.60 | 51160.2 |
|-----|-------|-----|---|--------|---------|

**PAR30 halogène réflecteur aluminium pour plantes 230V**  
**230V PAR30 Halogen Alu Plant Lamp**  
**PAR30 Halogeen plantenlamp 230V**  
**Lampadina alogena in alluminio per piante PAR30 230V**  
**PAR30 Halogen-Alu-Pflanzenlampe 230V**

230V HALOGEN

**E27****ø95mm***rosé, rosé, roze, rosato, rosé*

|     |      |           |   |        |         |
|-----|------|-----------|---|--------|---------|
| 75W | 95mm | flood 30° | 4 | 249.71 | 24971.0 |
|-----|------|-----------|---|--------|---------|



Plantia

Plantina

PLANTDART



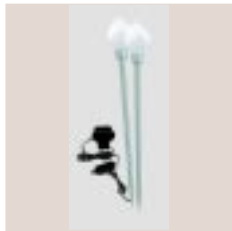

**Plantina, kit de 2, avec transfo fiche**  
**Plantina, set of 2, with plug-in transformer**  
**Plantina, 2-dlge set met stekkertrafo**  
**Plantina, set da 2, con trasformatore a spina**  
**Plantina, 2er-Set, mit Steckertrafo**

**G4****ø45mm***alu, alu, alu, color alluminio, alu*

2x10W

375mm

1

503.27

50327.0

**Plantia, kit de 2, avec transfo fiche**  
**Plantia, set of 2, with plug-in transformer**  
**Plantia, 2-dlge set met stekkertrafo**  
**Plantia, set da 2, con trasformatore a spina**  
**Plantia, 2er-Set, mit Steckertrafo**

**G4****ø45mm***noir, black, zwart, nero, schwarz*

2x10W

360mm

1

503.26

50326.3

**Plantdart, kit de 2 avec transfo fiche**  
**Plantdart, set of 2, with plug**  
**plantdart, 2 dlg set, met stekkertrafo**  
**Plantdart, set da 2, con trasformatore a spina**  
**Plantdart, 2er-Set, mit Steckertrafo**

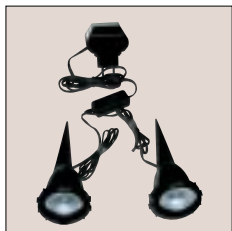
**G4****ø70mm***noir, black, zwart, nero, schwarz*

2x10W

170mm

1

503.25

50325.6

**Dichroïque halogène 12V, fermée**  
**halogen dichroic 12V lamp, with front-glass**  
**Halogeen-koudlichtspiegel 12V, met frontglas**  
**Dicroica 12V, con vetro di protezione**  
**Halogen-Kaltlichtspiegel 12V, mit Schutzglas**

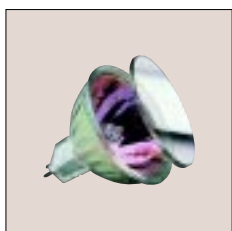
**GU5,3 ø51mm (MR16)***rosé, rosé, roze, rosato, rosé*

35W

45mm

FMW flood 38°

✓

10

8833.391

00832.4

50W

45mm

EXN flood 38°

✓

10

8833.591

00835.5

**Dichroïque halogène 12V ouverte**  
**Halogen Dichroic lamp 12V, without front-glass**  
**halogeen koudlichtspiegel, zonder frontglas**  
**Dicroica 12V, senza vetro di protezione**  
**Halogen-Kaltlichtspiegel 12V, ohne Schutzglas**

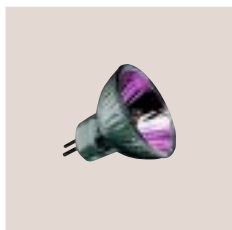
**GU4 ø35mm (MR11)***rosé, rosé, roze, rosato, rosé*

35W

35mm

FTH flood 38°

✓

10

838.391

00546.0



**Poirette**  
**Pygmy lamp**  
**schakelbordlampen**  
**Lampadina a pera**  
**Birnenlampe**



**E14** **ø25mm**

*clair, clear, helder, chiaro, klar*

|     |      |    |        |         |
|-----|------|----|--------|---------|
| 15W | 60mm | 16 | 800.10 | 80010.2 |
| 25W | 60mm | 16 | 800.20 | 80020.1 |



**E14** **ø25mm**

*dépoli, matt, mat, interno opaco, imatt*

|     |      |    |        |         |
|-----|------|----|--------|---------|
| 15W | 60mm | 16 | 801.10 | 80110.9 |
| 25W | 60mm | 16 | 801.20 | 80120.8 |



**E14** **ø25mm**

*bleu, blue, blauw, blu, blau*

|     |      |    |        |         |
|-----|------|----|--------|---------|
| 15W | 60mm | 16 | 810.10 | 81010.1 |
|-----|------|----|--------|---------|

TV- light



**Poirette four 300°**  
**Pygmy oven lamp 300°**  
**schakelbordlampen oven 300°**  
**Lampadina a pera per forno 300°**  
**Birnenlampe Backofen 300°**



**E14** **ø22mm**

*clair, clear, helder, chiaro, klar*

|     |      |    |        |         |
|-----|------|----|--------|---------|
| 15W | 50mm | 16 | 820.10 | 82010.0 |
|-----|------|----|--------|---------|



**Sphérique four 300°**  
**Oven Ball Lamp 300°**  
**kogellamp oven 300°**  
**Lampadina a goccia per forno 300°**  
**Tropfenlampe Backofen 300°**



**E14** **ø45mm**

*clair, clear, helder, chiaro, klar*

|     |      |   |        |         |
|-----|------|---|--------|---------|
| 25W | 75mm | 8 | 820.20 | 82020.9 |
| 40W | 75mm | 8 | 820.40 | 82040.7 |





Poirette machine à coudre  
 Pygmy sewing machine lamp  
 schakelbordlampen naaimachine  
 Lampadina a pera per macchine da cucire  
 Birnenlampe Nähmaschine

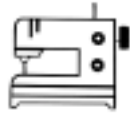

**BA15d** **ø16mm**

*clair, clear, helder, chiaro, klar*

|     |      |    |        |         |
|-----|------|----|--------|---------|
| 15W | 47mm | 16 | 808.10 | 80810.8 |
|-----|------|----|--------|---------|

Tube  
 Mini Tube Lamp (Signal)  
 buislamp  
 Lampadina tubolare Mini (segnale)  
 Röhrenlampe Mini (Signal)



**E14** **ø17mm**

*clair, clear, helder, chiaro, klar*

|     |      |    |        |         |
|-----|------|----|--------|---------|
| 15W | 52mm | 16 | 549.10 | 54910.0 |
|-----|------|----|--------|---------|

Tube taille 2  
 Tube Lamp Size 2  
 buislamp grootte 2  
 Lampadina tubolare misura 2  
 Röhrenlampe Größe 2



**E14** **ø20mm**

*clair, clear, helder, chiaro, klar*

|     |       |    |        |         |
|-----|-------|----|--------|---------|
| 25W | 114mm | 10 | 540.20 | 54020.6 |
| 40W | 114mm | 10 | 540.40 | 54040.4 |

Tube taille 3  
 Tube Lamp Size 3  
 buislamp grootte 3  
 Lampadina tubolare misura 3  
 Röhrenlampe Größe 3



**E27** **ø29mm**

*dépoli, matt, mat, interno opaco, imatt*

|     |      |    |        |         |
|-----|------|----|--------|---------|
| 25W | 87mm | 10 | 546.20 | 54620.8 |
|-----|------|----|--------|---------|



**E14** **ø29mm**

*dépoli, matt, mat, interno opaco, imatt*

|     |      |    |        |         |
|-----|------|----|--------|---------|
| 25W | 91mm | 10 | 545.20 | 54520.1 |
| 40W | 91mm | 10 | 545.40 | 54540.9 |

**Tube taille 4****Tube Lamp Size 4****buislamp grootte 4****Lampadina tubolare misura 4****Röhrenlampe Größe 4****E14****ø25mm***clair, clear, helder, chiaro, klar*

|     |      |    |        |         |
|-----|------|----|--------|---------|
| 25W | 80mm | 10 | 540.22 | 54022.0 |
| 40W | 80mm | 10 | 540.42 | 54042.8 |

**Tube taille 5****Tube Lamp Size 5****buislamp grootte 5****Lampadina tubolare misura 5****Röhrenlampe Größe 5****E14****ø20mm***clair, clear, helder, chiaro, klar*

|     |       |    |        |         |
|-----|-------|----|--------|---------|
| 25W | 135mm | 10 | 541.20 | 54120.3 |
| 40W | 135mm | 10 | 541.40 | 54140.1 |

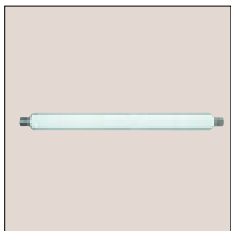
**Linolite****Strip-light****etalagelamp****Lampadina tubolare a filamento rettilineo****Soffite****S19****ø38mm***opale, opal, opaal, opale, opal*

|     |       |    |        |         |
|-----|-------|----|--------|---------|
| 40W | 309mm | 10 | 720.40 | 72040.0 |
| 60W | 309mm | 10 | 720.60 | 72060.8 |
| 75W | 309mm | 10 | 720.75 | 72075.2 |

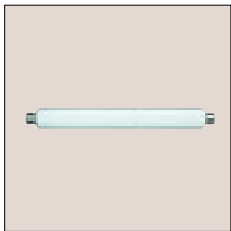
**S15****ø25mm***opale, opal, opaal, opale, opal*

|     |       |    |        |         |
|-----|-------|----|--------|---------|
| 25W | 284mm | 10 | 720.20 | 72020.2 |
| 25W | 221mm | 10 | 720.21 | 72021.9 |
| 40W | 221mm | 10 | 720.41 | 72041.7 |

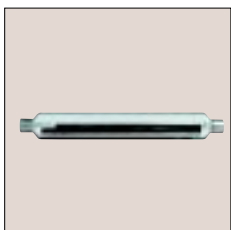
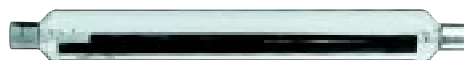
**Linolite demi-argentée****Semi-mirrored Strip-light****etalagelamp, half verspiegeld****Lampada tubolare a filamento rettilineo, semiargentata****Soffite, halb verspiegelt****S19****ø38mm***clair, clear, helder, chiaro, klar*

|     |       |    |        |         |
|-----|-------|----|--------|---------|
| 60W | 309mm | 10 | 721.60 | 72160.5 |
|-----|-------|----|--------|---------|

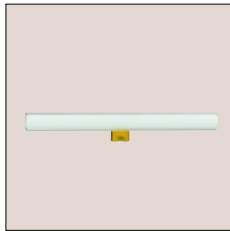
**Ampoule linéaire, 1 culot latéral****Linear Lamp, 1 Base****lineaire lampen, 1 voet****Lampadina lineare, 1 attacco****Linienlampe, 1 Socket****S14d1 ø30mm***opale, opal, opaal, opale, opal*

|     |       |   |         |         |
|-----|-------|---|---------|---------|
| 60W | 500mm | 6 | 730.601 | 00985.7 |
| 35W | 300mm | 6 | 730.301 | 00984.0 |

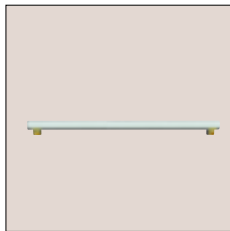
**Ampoule linéaire, 2 culots latéraux****Linear Lamp, 2 Bases****lineaire lampen, 2 voeten****Lampadina lineare, 2 attacchi****Linienlampe, 2 Socket****S14s ø30mm***opale, opal, opaal, opale, opal*

|      |        |    |        |         |
|------|--------|----|--------|---------|
| 120W | 1000mm | 16 | 730.20 | 73020.1 |
| 60W  | 500mm  | 25 | 730.60 | 73060.7 |
| 35W  | 300mm  | 25 | 730.30 | 73030.0 |

**applique linéaire avec ampoule & interrupteur****Linear Lamp with lamp and switch****Liniair armatuur met lamp + schakelaar****Lampada lineare con lampadina + interruttore****Linienleuchte mit Lampe + Schalter****S14s***blanc, white, wit, bianco, weiß*

|     |       |   |    |        |         |
|-----|-------|---|----|--------|---------|
| 35W | 300mm | ✓ | 10 | 733.30 | 73330.1 |
| 60W | 500mm | ✓ | 10 | 733.60 | 73360.8 |

**Applique linéaire avec interrupteur****Linear Lamp Fitting with Switch****lineair armatuur met schakelaar****Lampada lineare con interruttore****Linienleuchte mit Schalter****S14s***blanc, white, wit, bianco, weiß*

|     |       |    |        |         |
|-----|-------|----|--------|---------|
| 35W | 300mm | 10 | 731.30 | 73130.7 |
| 60W | 500mm | 10 | 731.60 | 73160.4 |





**Sphérique**  
**Ball Lamp**  
**kogellamp**  
**Lampadina a goccia**  
**Tropfenlampe**



**B22d** **ø45mm**

*clair, clear, helder, chiaro, klar*

|     |      |   |        |         |
|-----|------|---|--------|---------|
| 25W | 70mm | 8 | 118.21 | 11821.4 |
| 40W | 70mm | 8 | 118.41 | 11841.2 |
| 60W | 70mm | 8 | 118.61 | 11861.0 |



**B22d** **ø45mm**

*dépoli, matt, mat, interno opaco, imatt*

|     |      |   |        |         |
|-----|------|---|--------|---------|
| 25W | 70mm | 8 | 128.21 | 12821.3 |
| 40W | 70mm | 8 | 128.41 | 12841.1 |
| 60W | 70mm | 8 | 128.61 | 12861.9 |

**Flamme**  
**Candle Lamp**  
**kaarslamp**  
**Lampadina a candela**  
**Kerzenlampe**



**B22d** **ø35mm**

*clair, clear, helder, chiaro, klar*

|     |      |    |        |         |
|-----|------|----|--------|---------|
| 40W | 95mm | 10 | 441.41 | 44141.1 |
|-----|------|----|--------|---------|



**B22d** **ø35mm**

*dépoli, matt, mat, interno opaco, imatt*

|     |      |    |        |         |
|-----|------|----|--------|---------|
| 40W | 95mm | 10 | 444.41 | 44441.2 |
|-----|------|----|--------|---------|

**Flamme torsadée**  
**Candle Lamp Twisted**  
**gedraaide kaarslamp**  
**Lampadina a candela tortiglione**  
**Kerzenlampe gedreht**



**B22d** **ø35mm**

*dépoli, matt, mat, interno opaco, imatt*

|     |      |    |        |         |
|-----|------|----|--------|---------|
| 40W | 95mm | 10 | 451.41 | 45141.0 |
|-----|------|----|--------|---------|



**B22d** **ø50mm**

*satín, satin, satijn, satinato, satin*

|     |       |   |        |         |
|-----|-------|---|--------|---------|
| 40W | 140mm | 6 | 451.42 | 45142.7 |
| 60W | 140mm | 6 | 451.62 | 45162.5 |



Standard  
GLS  
AGL  
LIC  
AGL



**B22d** **ø60mm**

*clair, clear, helder, chiaro, klar*

|      |       |    |        |         |
|------|-------|----|--------|---------|
| 40W  | 105mm | 21 | 416.40 | 41640.2 |
| 60W  | 105mm | 21 | 416.60 | 41660.0 |
| 75W  | 105mm | 21 | 416.70 | 41670.9 |
| 100W | 105mm | 21 | 416.00 | 41600.6 |



**B22d** **ø60mm**

*dépoli, matt, mat, interno opaco, imatt*

|      |       |    |        |         |
|------|-------|----|--------|---------|
| 40W  | 105mm | 21 | 417.40 | 41740.9 |
| 60W  | 105mm | 21 | 417.60 | 41760.7 |
| 75W  | 105mm | 21 | 417.70 | 41770.6 |
| 100W | 105mm | 21 | 417.00 | 41700.3 |

**Krypton**



**B22d** **ø50mm**

*soft-opale, soft opal, softopaal, opale tenue, softopal*

|     |      |   |        |         |
|-----|------|---|--------|---------|
| 40W | 90mm | 8 | 433.41 | 43341.6 |
| 60W | 90mm | 8 | 433.61 | 43361.4 |

**Krypton**  
+10%  
*Soft Opal*



**B22d** **ø60mm**

*soft-opale, soft opal, softopaal, opale tenue, softopal*

|      |      |   |        |         |
|------|------|---|--------|---------|
| 75W  | 99mm | 6 | 433.71 | 43371.3 |
| 100W | 99mm | 6 | 433.01 | 43301.0 |

**Tube taille 4**  
**Tube Lamp Size 4**  
**buislamp grootte 4**  
**Lampadina tubolare misura 4**  
**Röhrenlampe Größe 4**



**B22d** **ø25mm**

*clair, clear, helder, chiaro, klar*

|     |      |    |        |         |
|-----|------|----|--------|---------|
| 25W | 60mm | 10 | 540.21 | 54021.3 |
| 40W | 60mm | 10 | 540.41 | 54041.1 |

**Poirette machine à coudre**  
**Pygmy sewing machine lamp**  
**schakelbordlampen naaimachine**  
**Lampadina a pera per macchine da cucire**  
**Birnenlampe Nähmaschine**

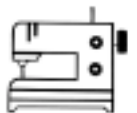

**BA15d** **ø16mm**

*clair, clear, helder, chiaro, klar*

|     |      |    |        |         |
|-----|------|----|--------|---------|
| 15W | 47mm | 16 | 808.10 | 80810.8 |
|-----|------|----|--------|---------|



**Sphérique**  
**Ball Lamp**  
**kogellamp**  
**Lampadina a goccia**  
**Tropfenlampe**

**E27****ø45mm***rouge, red, rood, rosso, rot*

25W

70mm

8

401.31

40131.6

**E27****ø45mm***jaune, yellow, geel, giallo, gelb*

25W

70mm

8

401.32

40132.3

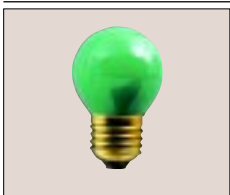
**E27****ø45mm***vert, green, groen, verde, grün*

25W

70mm

8

401.33

40133.0

**E27****ø45mm***bleu, blue, blauw, blu, blau*

25W

70mm

8

401.34

40134.7

**E14****ø45mm***rouge, red, rood, rosso, rot*

25W

75mm

8

401.21

40121.7

**E14****ø45mm***jaune, yellow, geel, giallo, gelb*

25W

75mm

8

401.22

40122.4

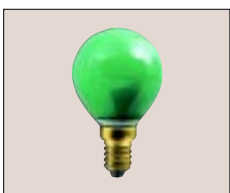
**E14****ø45mm***vert, green, groen, verde, grün*

25W

75mm

8

401.23

40123.1

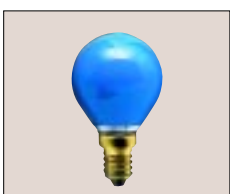
**E14****ø45mm***bleu, blue, blauw, blu, blau*

25W

75mm

8

401.24

40124.8



**Flamme**  
**Candle Lamp**  
**kaarslamp**  
**Lampadina a candela**  
**Kerzenlampe**



 **E14** **ø35mm**

*rouge, red, rood, rosso, rot*

25W 97mm 10 402.21 40221.4



 **E14** **ø35mm**

*jaune, yellow, geel, giallo, gelb*

25W 97mm 10 402.22 40222.1



 **E14** **ø35mm**

*vert, green, groen, verde, grün*

25W 97mm 10 402.23 40223.8



 **E14** **ø35mm**

*bleu, blue, blauw, blu, blau*

25W 97mm 10 402.24 40224.5

**Poirette**  
**Pygmy lamp**  
**schakelbordlampen**  
**Lampadina a pera**  
**Birnenlampe**



 **E14** **ø25mm**

*rouge, red, rood, rosso, rot*

15W 60mm 16 800.11 80011.9



 **E14** **ø25mm**

*jaune, yellow, geel, giallo, gelb*

15W 60mm 16 800.12 80012.6

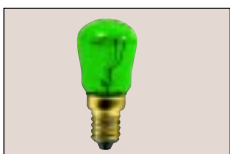

 **E14** **ø25mm**

*vert, green, groen, verde, grün*

15W 60mm 16 800.13 80013.3



 **E14** **ø25mm**

*bleu, blue, blauw, blu, blau*

15W 60mm 16 810.10 81010.1

**Standard**  
**GLS**  
**AGL**  
**LIC**  
**AGL**



**E27** **ø60mm**

*rouge, red, rood, rosso, rot*

|     |       |   |        |         |
|-----|-------|---|--------|---------|
| 25W | 105mm | 6 | 400.21 | 40021.0 |
| 40W | 105mm | 6 | 400.41 | 40041.8 |



**E27** **ø60mm**

*jaune, yellow, geel, giallo, gelb*

|     |       |   |        |         |
|-----|-------|---|--------|---------|
| 25W | 105mm | 6 | 400.22 | 40022.7 |
| 40W | 105mm | 6 | 400.42 | 40042.5 |



**E27** **ø60mm**

*vert, green, groen, verde, grün*

|     |       |   |        |         |
|-----|-------|---|--------|---------|
| 25W | 105mm | 6 | 400.23 | 40023.4 |
| 40W | 105mm | 6 | 400.43 | 40043.2 |



**E27** **ø60mm**

*bleu, blue, blauw, blu, blau*

|     |       |   |        |         |
|-----|-------|---|--------|---------|
| 25W | 105mm | 6 | 400.24 | 40024.1 |
| 40W | 105mm | 6 | 400.44 | 40044.9 |

**Parinsecte**  
**Anti-insect**  
**Anti Insecta**  
**Anti Insecta**  
**Anti Insecta**



**E27** **ø60mm**

*jeune spécial, Special yellow, geel, giallo speciale, spezial gelb*

|     |       |   |        |         |
|-----|-------|---|--------|---------|
| 40W | 105mm | 6 | 460.40 | 46040.5 |
| 60W | 105mm | 6 | 460.60 | 46060.3 |





**R50 Réflecteur**  
**R50 Reflector Lamp**  
**R50 reflectorlamp**  
**Riflettore R50**  
**R50 Reflektorlampe**

**E14****ø50mm***rouge-clair, red-clear, rood-helder, rosso-chiaro, rot-klar*

25W

86mm

8

201.21

20121.3

**E14****ø50mm***jaune-clair, yellow-clear, geel-helder, giallo-chiaro, gelb-klar*

25W

86mm

8

201.22

20122.0

**E14****ø50mm***vert-clair, green-clear, groen-helder, verde-chiaro, grün-klar*

25W

86mm

8

201.23

20123.7

**E14****ø50mm***bleu-clair, blue-clear, blauw-helder, blu-chiaro, blau-klar*

25W

86mm

8

201.24

20124.4

**R63 Réflecteur**  
**R63 Reflector Lamp**  
**R63 reflectorlamp**  
**Riflettore R63**  
**R63 Reflektorlampe**

**E27****ø63mm***rouge-clair, red-clear, rood-helder, rosso-chiaro, rot-klar*

40W

103mm

6

230.41

23041.1

**E27****ø63mm***jaune-clair, yellow-clear, geel-helder, giallo-chiaro, gelb-klar*

40W

103mm

6

230.42

23042.8

**E27****ø63mm***vert-clair, green-clear, groen-helder, verde-chiaro, grün-klar*

40W

103mm

6

230.43

23043.5

**E27** **ø63mm***bleu-clair, blue-clear, blauw-helder, blu-chiaro, blau-klar*

40W

103mm

6

230.44

23044.2

**E27** **ø63mm***violet-clair, violet-clear, violet-helder, violetto-chiaro, violett-klar*

40W

103mm

6

230.46

23046.6

**R80 Réflecteur**  
**R80 Reflector Lamp**  
**R80 reflectorlamp**  
**Riflettore R80**  
**R80 Reflektorlampe**

**E27** **ø80mm***rouge-clair, red-clear, rood-helder, rosso-chiaro, rot-klar*

60W

116mm

5

250.61

25061.7

**E27** **ø80mm***jaune-clair, yellow-clear, geel-helder, giallo-chiaro, gelb-klar*

60W

116mm

5

250.62

25062.4

**E27** **ø80mm***vert-clair, green-clear, groen-helder, verde-chiaro, grün-klar*

60W

116mm

5

250.63

25063.1

**E27** **ø80mm***bleu-clair, blue-clear, blauw-helder, blu-chiaro, blau-klar*

60W

116mm

5

250.64

25064.8

**E27** **ø80mm***violet-clair, violet-clear, violet-helder, violetto-chiaro, violett-klar*

60W

116mm

5

250.66

25066.2



**PAR38 réflecteur**  
**PAR 38 reflector lamp**  
**PAR38 reflectorlamp**  
**Riflettore PAR38**  
**PAR38 Reflektorlampe**



**E27** **ø122mm**

*rouge, red, rood, rosso, rot*

80W 136mm ✓ 10 272.81 27281.7



**E27** **ø122mm**

*jaune, yellow, geel, giallo, gelb*

80W 136mm ✓ 10 272.82 27282.4



**E27** **ø122mm**

*vert, green, groen, verde, grün*

80W 136mm ✓ 10 272.83 27283.1



**E27** **ø122mm**

*bleu, blue, blauw, blu, blau*

80W 136mm ✓ 10 272.84 27284.8

**Flamme scintillante**  
**Flickering Candle**  
**flakkerkaars**  
**Candela a luce vacillante**  
**Flackerkerze**



**E27** **ø35mm**

*clair, clear, helder, chiaro, klar*

3W 90mm 10 531.00 53100.6

**E14** **ø35mm**

*clair, clear, helder, chiaro, klar*

3W 97mm 10 530.00 53000.9



**E14** **ø35mm**

*rouge, red, rood, rosso, rot*

3W 97mm 10 530.01 53001.6



**E14** **ø35mm**

*jaune, yellow, geel, giallo, gelb*

3W 97mm 10 530.02 53002.3



lumière noire  
blacklight  
Blacklight  
luce nera  
Schwarzlicht



**E27** **ø60mm**

lumière noire, blacklight, Blacklight, luce nera, Schwarzlicht

|     |       |   |        |         |
|-----|-------|---|--------|---------|
| 75W | 105mm | 6 | 590.70 | 59070.6 |
|-----|-------|---|--------|---------|



**E27** **ø80mm**

lumière noire, blacklight, Blacklight, luce nera, Schwarzlicht

|     |       |   |        |         |
|-----|-------|---|--------|---------|
| 75W | 103mm | 5 | 591.70 | 59170.3 |
|-----|-------|---|--------|---------|



**G23** **ø32mm**

lumière noire, blacklight, Blacklight, luce nera, Schwarzlicht

|    |       |    |        |         |
|----|-------|----|--------|---------|
| 9W | 168mm | 10 | 592.70 | 59270.0 |
|----|-------|----|--------|---------|



**G13** **ø26mm**

lumière noire, blacklight, Blacklight, luce nera, Schwarzlicht

|     |       |   |        |         |
|-----|-------|---|--------|---------|
| 18W | 590mm | 6 | 593.20 | 59320.2 |
| 36W | 120cm | 6 | 593.40 | 59340.0 |





**Ampoule fluo DecoPipe**  
**DecoPipe Energy-saving lamp**  
**Spaarlamp DecoPipe**  
**Lampada a risparmio energetico DecoPipe**  
**Energiesparlampe DecoPipe**

**E14****ø38mm****8.000h***blanc chaud, warm tone, warmwit, tonalita calda, warmton*

|          |       |    |        |         |
|----------|-------|----|--------|---------|
| 5W(≈25W) | 124mm | 10 | 894.05 | 89405.7 |
| 9W(≈50W) | 145mm | 10 | 894.09 | 89409.5 |

**E27****ø38mm****8.000h***blanc chaud, warm tone, warmwit, tonalita calda, warmton*

|           |       |    |        |         |
|-----------|-------|----|--------|---------|
| 7W(≈40W)  | 126mm | 10 | 894.07 | 89407.1 |
| 11W(≈60W) | 145mm | 10 | 894.11 | 89411.8 |

**E14****ø38mm****8.000h***blanc chaud, warm tone, warmwit, tonalita calda, warmton*

|          |       |    |        |         |
|----------|-------|----|--------|---------|
| 5W(≈25W) | 135mm | 10 | 894.15 | 89415.6 |
| 9W(≈50W) | 155mm | 10 | 894.19 | 89419.4 |

**E27****ø38mm****8.000h***blanc chaud, warm tone, warmwit, tonalita calda, warmton*

|           |       |    |        |         |
|-----------|-------|----|--------|---------|
| 7W(≈40W)  | 174mm | 10 | 894.17 | 89417.0 |
| 11W(≈60W) | 185mm | 10 | 894.21 | 89421.7 |





Globe électronique  
Globe electronic  
Globe elektronisch  
Globe electronic  
Globe electronic



**E27** **ø110mm** **8.000h**

opale/blanc chaud extra, opal/extra warm tone, opaal/warmtoon extra, opale/tonalità calda, opal/warmton extra

|            |       |   |               |         |
|------------|-------|---|---------------|---------|
| 11W(≈60W)  | 165mm | 6 | <b>883.14</b> | 88314.3 |
| 15W(≈75W)  | 165mm | 6 | <b>883.15</b> | 88315.0 |
| 20W(≈100W) | 165mm | 6 | <b>883.20</b> | 88320.4 |



**E27** **ø90mm** **8.000h**

opale/blanc chaud extra, opal/extra warm tone, opaal/warmtoon extra, opale/tonalità calda, opal/warmton extra

|           |       |    |               |         |
|-----------|-------|----|---------------|---------|
| 11W(≈60W) | 142mm | 10 | <b>893.16</b> | 89316.6 |
| 15W(≈75W) | 142mm | 10 | <b>893.18</b> | 89318.0 |

Miniglobe électronique  
Electronic Moniglobe  
Miniglobe elektronisch  
Miniglobe electronic  
Miniglobe electronic



**E14** **ø60mm** **8.000h**

opale/blanc chaud extra, opal/extra warm tone, opaal/warmtoon extra, opale/tonalità calda, opal/warmton extra

|          |       |    |               |         |
|----------|-------|----|---------------|---------|
| 5W(≈25W) | 98mm  | 10 | <b>893.05</b> | 89305.0 |
| 7W(≈40W) | 112mm | 10 | <b>893.07</b> | 89307.4 |



**E27** **ø60mm** **8.000h**

opale/blanc chaud extra, opal/extra warm tone, opaal/warmtoon extra, opale/tonalità calda, opal/warmton extra

|          |       |    |               |         |
|----------|-------|----|---------------|---------|
| 5W(≈25W) | 98mm  | 10 | <b>893.15</b> | 89315.9 |
| 7W(≈40W) | 112mm | 10 | <b>893.17</b> | 89317.3 |

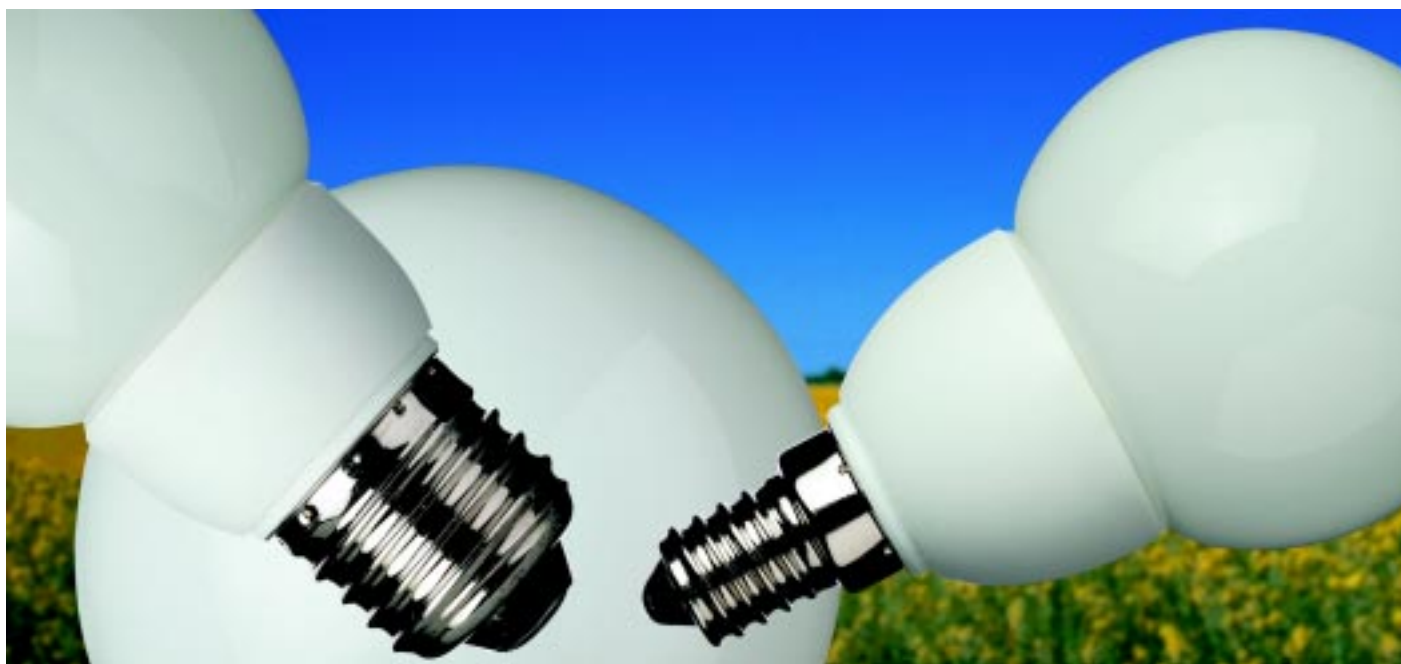



## Standard électronique

GLS electronic

AGL elektronisch

LIC electronic

AGL electronic

 **E27****ø68mm** **8.000h***opale/blanc chaud extra, opal/extra warm tone, opaal/warmtoon extra, opale/tonalità calda, opal/warmton extra*

|            |       |    |               |         |
|------------|-------|----|---------------|---------|
| 7W(≈40W)   | 110mm | 10 | <b>890.07</b> | 89007.3 |
| 9W(≈50W)   | 118mm | 10 | <b>890.09</b> | 89009.7 |
| 11W(≈60W)  | 126mm | 10 | <b>890.11</b> | 89011.0 |
| 15W(≈75W)  | 140mm | 10 | <b>890.15</b> | 89015.8 |
| 20W(≈100W) | 150mm | 10 | <b>890.20</b> | 89020.2 |

## Flamme électronique

Candle Lamp Electronic

Kaarsenlamp elektronisch

Lampadina a candela electronic

Kerzenlampe electronic

 **E14****ø44mm** **8.000h***opale/blanc chaud extra, opal/extra warm tone, opaal/warmtoon extra, opale/tonalità calda, opal/warmton extra*

|          |       |    |               |         |
|----------|-------|----|---------------|---------|
| 3W(≈15W) | 108mm | 10 | <b>891.03</b> | 89103.2 |
| 5W(≈25W) | 126mm | 10 | <b>891.05</b> | 89105.6 |
| 7W(≈40W) | 136mm | 10 | <b>891.07</b> | 89107.0 |

 **E27****ø44mm** **8.000h***opale/blanc chaud extra, opal/extra warm tone, opaal/warmtoon extra, opale/tonalità calda, opal/warmton extra*

|          |       |    |               |         |
|----------|-------|----|---------------|---------|
| 5W(≈25W) | 122mm | 10 | <b>891.15</b> | 89115.5 |
| 7W(≈40W) | 132mm | 10 | <b>891.17</b> | 89117.9 |
| 9W(≈50W) | 155mm | 10 | <b>891.19</b> | 89119.3 |

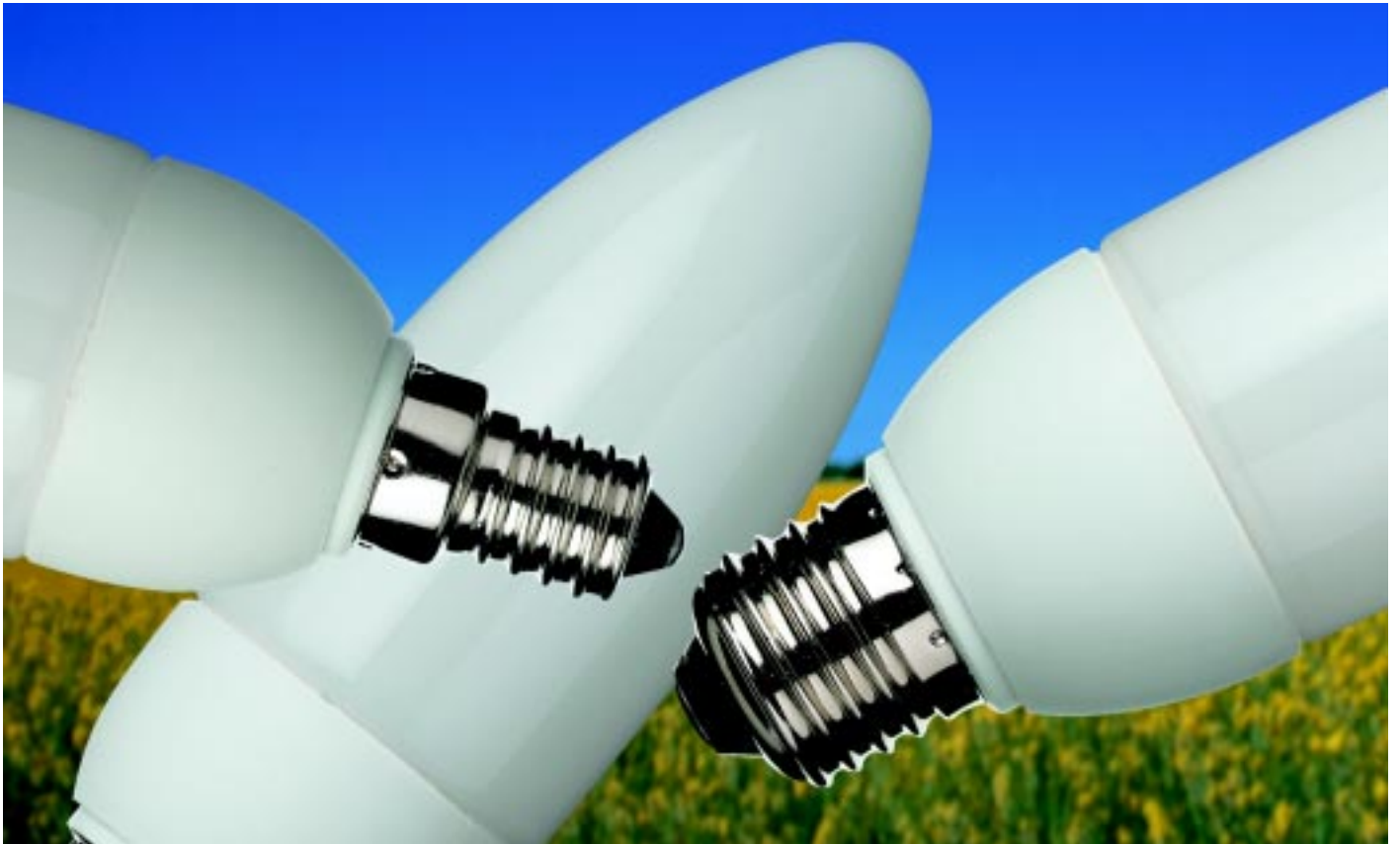



**R50 réflecteur à économie d'énergie**  
**Energy-saving R50 Reflector Lamp**  
**R50 Reflector energiespaarlamp**  
**Riflettore a risparmio energetico R50**  
**R50 Reflektor-Energiesparlampe**

**E14****ø50mm****8.000h***blanc chaud extra, extra warm tone, homelight de luxe, tono extra caldo, warmton extra*

|          |       |          |    |               |         |
|----------|-------|----------|----|---------------|---------|
| 5W(≈25W) | 97mm  | R50 110° | 10 | <b>892.05</b> | 89205.3 |
| 7W(≈40W) | 103mm | R50 110° | 10 | <b>892.07</b> | 89207.7 |

**R63 réflecteur à économie d'énergie**  
**Energy-saving R63 Reflector Lamp**  
**R63 Reflector energiespaarlamp**  
**Riflettore a risparmio energetico R63**  
**R63 Reflektor-Energiesparlampe**

**E27****ø63mm****8.000h***blanc chaud extra, extra warm tone, homelight de luxe, tono extra caldo, warmton extra*

|          |       |          |    |               |         |
|----------|-------|----------|----|---------------|---------|
| 5W(≈25W) | 106mm | R63 100° | 10 | <b>892.15</b> | 89215.2 |
| 7W(≈40W) | 116mm | R63 100° | 10 | <b>892.17</b> | 89217.6 |

**R80 réflecteur à économie d'énergie**  
**Energy-saving R80 Reflector Lamp**  
**R80 Reflector energiespaarlamp**  
**Riflettore a risparmio energetico R80**  
**R80 Reflektor-Energiesparlampe**

**E27****ø80mm****8.000h***blanc chaud extra, extra warm tone, homelight de luxe, tono extra caldo, warmton extra*

|          |       |          |    |               |         |
|----------|-------|----------|----|---------------|---------|
| 7W(≈40W) | 120mm | R80 110° | 10 | <b>892.27</b> | 89227.5 |
| 9W(≈50W) | 120mm | R80 110° | 10 | <b>892.29</b> | 89229.9 |

**R95 réflecteur à économie d'énergie**  
**Energy-saving R95 Reflector Lamp**  
**R95 Reflector energiespaarlamp**  
**Riflettore a risparmio energetico R95**  
**R95 Reflektor-Energiesparlampe**

**E27****ø95mm****8.000h***blanc chaud extra, extra warm tone, homelight de luxe, tono extra caldo, warmton extra*

|           |       |          |    |               |         |
|-----------|-------|----------|----|---------------|---------|
| 15W(≈75W) | 148mm | R95 100° | 10 | <b>892.25</b> | 89225.1 |
|-----------|-------|----------|----|---------------|---------|

**PAR38 réflecteur à économie d'énergie**  
**PAR 38 energy-saving reflector lamp**  
**PAR38 reflector energiespaarlamp**  
**Riflettore a risparmio energetico PAR38**  
**PAR38 Reflektor-Energiesparlampe**

**E27****ø120mm****8.000h***blanc chaud extra, extra warm tone, homelight de luxe, tono extra caldo, warmton extra*

|            |       |       |    |               |         |
|------------|-------|-------|----|---------------|---------|
| 20W(≈100W) | 136mm | PAR38 | 10 | <b>892.20</b> | 89220.6 |
|------------|-------|-------|----|---------------|---------|



Mini électronique  
Mini Electronic  
Mini elektronisch  
Mini electronic  
Mini electronic

**E14****ø42mm****8.000h***blanc chaud extra, extra warm tone, homelight de luxe, tono extra caldo, warmton extra*

|           |       |    |               |         |
|-----------|-------|----|---------------|---------|
| 5W(≈25W)  | 112mm | 10 | <b>882.95</b> | 88295.5 |
| 7W(≈40W)  | 122mm | 10 | <b>882.97</b> | 88297.9 |
| 9W(≈50W)  | 132mm | 10 | <b>882.91</b> | 88291.7 |
| 11W(≈60W) | 142mm | 10 | <b>882.90</b> | 88290.0 |

**E27****ø42mm****8.000h***blanc chaud extra, extra warm tone, homelight de luxe, tono extra caldo, warmton extra*

|           |       |    |               |         |
|-----------|-------|----|---------------|---------|
| 7W(≈40W)  | 122mm | 10 | <b>882.07</b> | 88207.8 |
| 9W(≈50W)  | 132mm | 10 | <b>882.09</b> | 88209.2 |
| 11W(≈60W) | 142mm | 10 | <b>882.11</b> | 88211.5 |
| 15W(≈75W) | 162mm | 10 | <b>882.15</b> | 88215.3 |

Trio électronique  
Trio Electronic  
Trio elektronisch  
Trio electronic  
Trio electronic

**E27****ø48mm****8.000h***blanc chaud extra, extra warm tone, homelight de luxe, tono extra caldo, warmton extra*

|            |       |    |               |         |
|------------|-------|----|---------------|---------|
| 15W(≈75W)  | 138mm | 10 | <b>882.16</b> | 88216.0 |
| 20W(≈100W) | 148mm | 10 | <b>882.21</b> | 88221.4 |
| 23W(≈120W) | 165mm | 10 | <b>882.23</b> | 88223.8 |

Quadro électronique  
Quadro electronic  
Quadro elektronisch  
Quadro electronic  
Quadro electronic

**E27****ø56mm****8.000h***blanc chaud extra, extra warm tone, homelight de luxe, tono extra caldo, warmton extra*

|            |       |    |               |         |
|------------|-------|----|---------------|---------|
| 15W(≈75W)  | 113mm | 10 | <b>884.15</b> | 88415.7 |
| 20W(≈100W) | 123mm | 10 | <b>884.20</b> | 88420.1 |
| 25W(≈120W) | 148mm | 10 | <b>884.25</b> | 88425.6 |





## Duo

**G23****ø32mm****10.000h***blanc chaud extra, extra warm tone, homelight de luxe, tono extra caldo, warmton extra*

|           |       |    |               |         |
|-----------|-------|----|---------------|---------|
| 5W(≈25W)  | 105mm | 10 | <b>880.05</b> | 88005.0 |
| 7W(≈40W)  | 135mm | 10 | <b>880.07</b> | 88007.4 |
| 9W(≈50W)  | 168mm | 10 | <b>880.09</b> | 88009.8 |
| 11W(≈60W) | 235mm | 10 | <b>880.11</b> | 88011.1 |

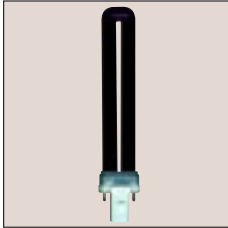
**G23****ø32mm****8.000h***lumière noire, blacklight, Blacklight, luce nera, Schwarzlicht*

|    |       |    |               |         |
|----|-------|----|---------------|---------|
| 9W | 168mm | 10 | <b>592.70</b> | 59270.0 |
|----|-------|----|---------------|---------|

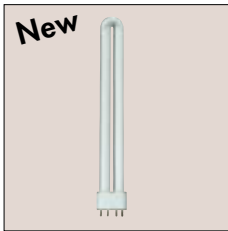

New

**2G11****ø44mm****8.000h***blanc neutre, coolwhite, cool-white, bianco ghiaccio, coolwhite*

|     |       |    |               |         |
|-----|-------|----|---------------|---------|
| 36W | 411mm | 10 | <b>881.30</b> | 88130.9 |
|-----|-------|----|---------------|---------|

## PLC Quadro

**G24d1****ø34mm****10.000h***blanc chaud extra, extra warm tone, homelight de luxe, tono extra caldo, warmton extra*

|            |       |    |               |         |
|------------|-------|----|---------------|---------|
| 10W(≈60W)  | 110mm | 10 | <b>881.10</b> | 88110.1 |
| 13W(≈75W)  | 135mm | 10 | <b>881.13</b> | 88113.2 |
| 18W(≈100W) | 155mm | 10 | <b>881.18</b> | 88118.7 |

## Thorn 2D

**G24****8.000h***blanc chaud extra, extra warm tone, homelight de luxe, tono extra caldo, warmton extra*

|           |       |    |               |         |
|-----------|-------|----|---------------|---------|
| 16W(≈75W) | 120mm | 10 | <b>887.16</b> | 88716.5 |
|-----------|-------|----|---------------|---------|

## Kit de modification 5-11W

## Conversion Set 5-11W

## vervangingsset 5-11W

## Set modificazione 5-11W

## Umrüstsatz 5-11W

**G23***blanc, white, wit, bianco, weiß*

|   |       |   |               |         |
|---|-------|---|---------------|---------|
| - | 155mm | 1 | <b>884.00</b> | 88400.3 |
|---|-------|---|---------------|---------|

## Adaptateur électronique pour PLC Quadro 8-13W

## Electronic energy-saving adapter, for PLC Quadro 8-13W

## electronische adapter voor PLC quadro 8-13W

## Adattatore elettronico, per PLC Quadro 8-13W

## Electronic Sparadapter, für PLC Quadro 8-13W

**E27****ø40mm***blanc, white, wit, bianco, weiß*

|       |      |    |               |         |
|-------|------|----|---------------|---------|
| 8-13W | 70mm | 10 | <b>961.01</b> | 96101.8 |
|-------|------|----|---------------|---------|



**Tube fluorescent**  
**Fluorescent Tubes**  
**fluorescentielampen**  
**Lampadine tubolari fluorescenti**  
**Leuchtstoffröhre**

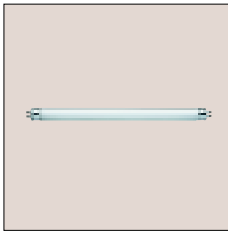

**G5** **ø16mm** **5.000h**  
*blanc chaud, warm tone, warmwit, tonalita calda, warmton*

|     |       |    |        |         |
|-----|-------|----|--------|---------|
| 4W  | 136mm | 6  | 885.04 | 88504.8 |
| 6W  | 212mm | 6  | 885.06 | 88506.2 |
| 8W  | 288mm | 6  | 885.08 | 88508.6 |
| 13W | 517mm | 10 | 885.13 | 88513.0 |

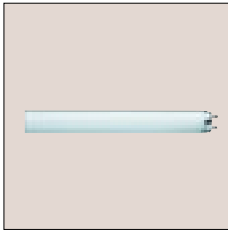

**G13** **ø26mm** **8.000h**  
*blanc chaud, warm tone, warmwit, tonalita calda, warmton*

|     |       |    |        |         |
|-----|-------|----|--------|---------|
| 15W | 440mm | 6  | 885.15 | 88515.4 |
| 18W | 590mm | 25 | 885.18 | 88518.5 |

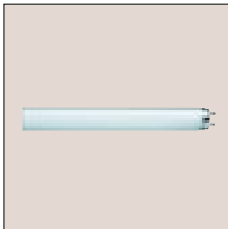

**G13** **ø26mm** **8.000h**  
*lumière du jour, daylight, daglicht, luce giorno, daylight*

|     |       |    |        |         |
|-----|-------|----|--------|---------|
| 18W | 590mm | 25 | 885.19 | 88519.2 |
| 36W | 120cm | 25 | 885.36 | 88536.9 |
| 58W | 150cm | 25 | 885.58 | 88558.1 |



New

**G13** **ø26mm** **20.000h**  
*blanc neutre, coolwhite, cool-white, bianco ghiaccio, coolwhite*

|     |       |   |        |         |
|-----|-------|---|--------|---------|
| 30W | 895mm | 6 | 885.20 | 88520.8 |
|-----|-------|---|--------|---------|

**Tube fluo lumière noire**  
**Fluorescent Tubes Black Light**  
**fluorescentielamp blacklight**  
**Lampadine tubolari fluorescenti a luce nera**  
**Leuchtstoffröhre Schwarzlicht**

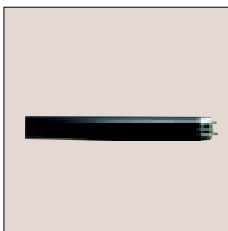

**G13** **ø26mm** **8.000h**  
*lumière noire, blacklight, Blacklight, luce nera, Schwarzlicht*

|     |       |   |        |         |
|-----|-------|---|--------|---------|
| 18W | 590mm | 6 | 593.20 | 59320.2 |
| 36W | 120cm | 6 | 593.40 | 59340.0 |

**Tube fluo circulaire**  
**Fluorescent Tubes Ring Form**  
**cirkelvormige fluorescentielampen**  
**Lampadine tubolari fluorescenti circolari**  
**Leuchtstoffröhre Ringform**



**G10q** **ø30mm** **8.000h**  
*blanc chaud, warm tone, warmwit, tonalita calda, warmton*

|     |       |    |        |         |
|-----|-------|----|--------|---------|
| 32W | 305mm | 12 | 884.32 | 88432.4 |
| 40W | 405mm | 12 | 884.40 | 88440.9 |



**Tube fluo en U**  
**Fluorescent Tubes U-Form**  
**U-vormige fluorescentielampen**  
**Lampadine tubolari fluorescenti a forma di U**  
**Leuchtstoffröhre U-Form**

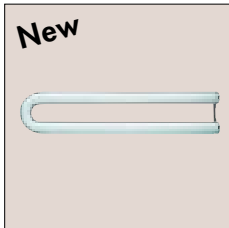

**2G13** **ø26mm** **8.000h**

*blanc chaud, warm tone, warmwit, tonalita calda, warmton*

|     |       |    |        |         |
|-----|-------|----|--------|---------|
| 36W | 600mm | 12 | 884.45 | 88445.4 |
|-----|-------|----|--------|---------|

**Starter VDE**  
**VDE Starter**  
**VDE-starter**  
**Starter VDE**  
**VDE Starter**



*blanc, white, wit, bianco, weiß*

|       |   |    |        |         |
|-------|---|----|--------|---------|
| 4-80W | - | 10 | 884.80 | 88480.5 |
|-------|---|----|--------|---------|



*blanc, white, wit, bianco, weiß*

|       |   |    |        |         |
|-------|---|----|--------|---------|
| 4-22W | - | 10 | 884.22 | 88422.5 |
|-------|---|----|--------|---------|

**Applique fluo mince**  
**Slimline Fluorescent Battens**  
**smalvormarmatuur**  
**Lampadina a forma sottile**  
**Schmalformleuchte**

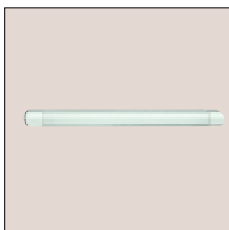

**G13**

*blanc, white, wit, bianco, weiß*

|       |   |   |   |        |         |
|-------|---|---|---|--------|---------|
| 1x15W | - | ✓ | 4 | 750.50 | 75050.6 |
| 1x18W | - | ✓ | 4 | 750.80 | 75080.3 |
| 1x30W | - | ✓ | 4 | 750.00 | 75000.1 |
| 1x36W | - | ✓ | 4 | 750.60 | 75060.5 |

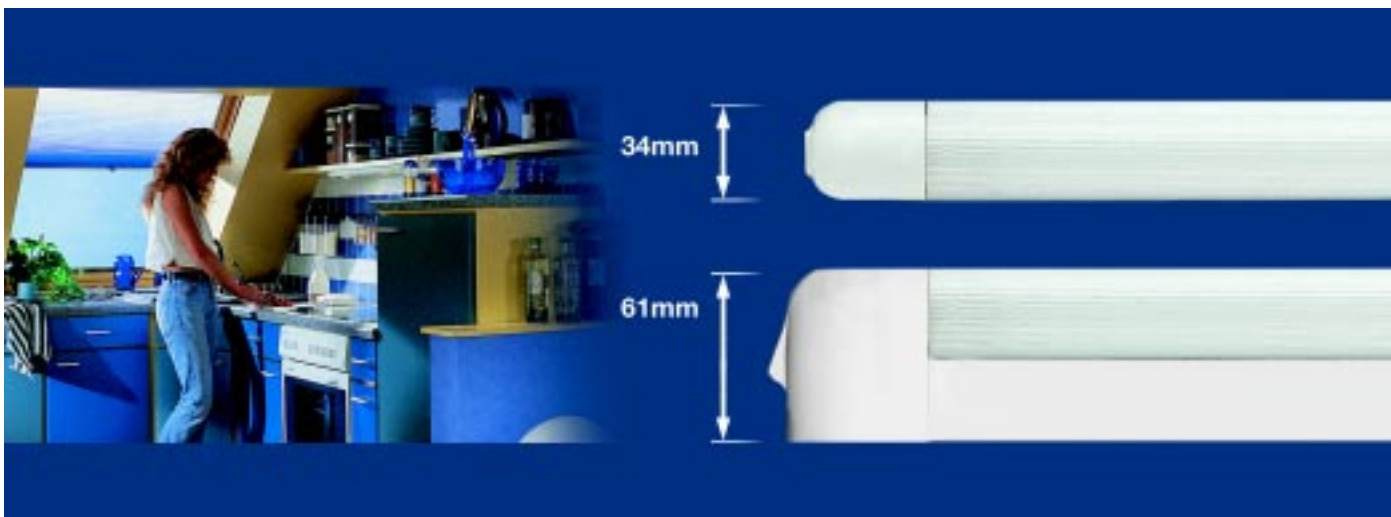



**Applique fluo mince**  
**Slimline Luminaire**  
**smalvormarmatuur**  
**Lampada a forma sottile**  
**Schlankformleuchte**

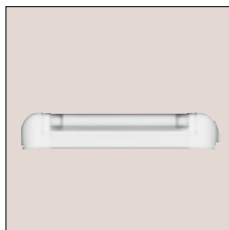

**G5**

*blanc chaud, warm white, warmwit, bianco caldo, warmweiß*

|       |             |   |   |               |         |
|-------|-------------|---|---|---------------|---------|
| 1x6W  | 280x42x22mm | ✓ | 1 | <b>751.06</b> | 75106.0 |
| 1x8W  | 360x42x22mm | ✓ | 1 | <b>751.08</b> | 75108.4 |
| 1x13W | 590x42x22mm | ✓ | 1 | <b>751.13</b> | 75113.8 |



**applique placard TIP**  
**TIP under-cabinet light**  
**TIP kastverlichting**  
**Lampada TIP da installare sotto armadietti/ripiani**  
**TIP Unterschrankleuchte**

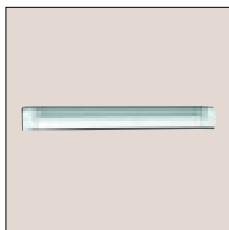

**G5**

*blanc, white, wit, bianco, weiß*

**TIP**

|       |             |   |   |               |         |
|-------|-------------|---|---|---------------|---------|
| 1x8W  | 345x42x21mm | ✓ | 1 | <b>752.08</b> | 75208.1 |
| 1x13W | 575x42x21mm | ✓ | 1 | <b>752.13</b> | 75213.5 |



**Applique placard**  
**Under-Cabinet Light-Fitting**  
**keukenarmatuur**  
**Lampada da installare sotto armadietti/ripiani**  
**Unterschrankleuchte**



**G5**

*blanc, white, wit, bianco, weiß*

|       |             |   |   |               |         |
|-------|-------------|---|---|---------------|---------|
| 1x8W  | 345x24x80mm | ✓ | 1 | <b>750.08</b> | 75008.7 |
| 1x13W | 570x24x80mm | ✓ | 1 | <b>750.13</b> | 75013.1 |

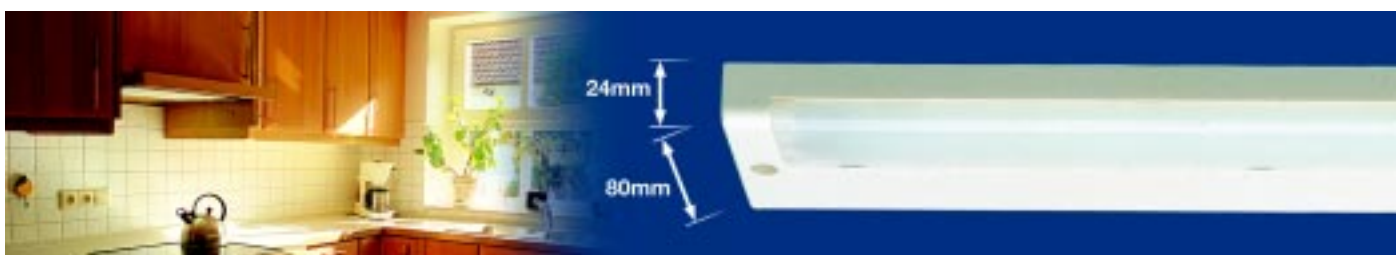

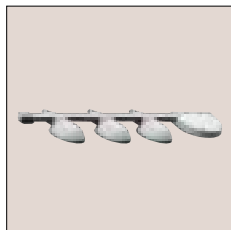
**Inline****Halogen Inline****Halogeen Inline****Inline alogeno****Halogen-Inline, 3er-Set mit Trafo***blanc, white, wit, bianco, weiß*

60VA, 3x20W

1030x100x35mm

-

✓

1

984.95

98495.6

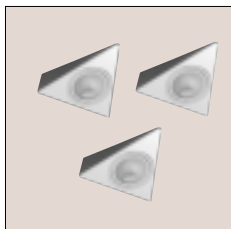
**Spot placard triangulaire****Under-cabint lamp, triangular****Keukenverlichting, 3-hoekig****Lampada da installare sotto armadietti, triangolare****Unterschrankleuchte, dreieckig, 3er-Set mit Trafo***blanc, white, wit, bianco, weiß*

70VA, 3x20W

130x130x40mm

-

1

984.25

98425.3

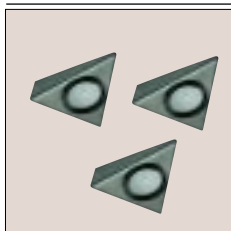
*acier brossé, brushed iron, staal geborsteld, ferro spazzolato, Eisen gebürstet*

70VA, 3x20W

130x130x40mm

-

1

984.27

98427.7

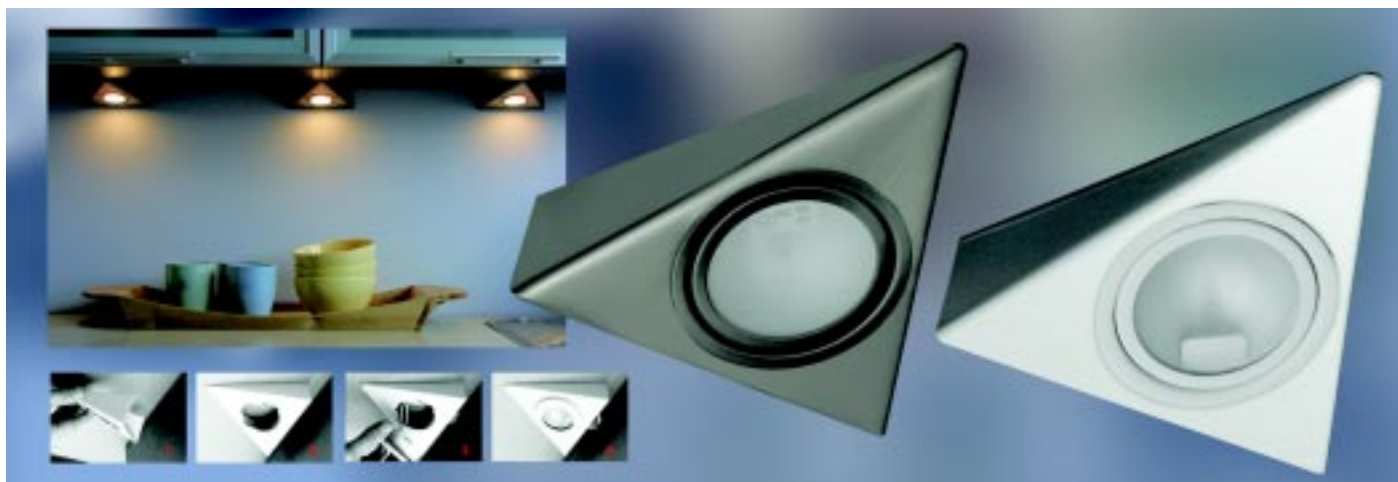



**Halogène applique placard**  
**Halogen-Under-Cabinet Light-Fitting**  
**halogeen keukenarmatuur**  
**Lampada alogena da installare sotto armadietti/ripiani**  
**Halogen-Unterschrankleuchte**

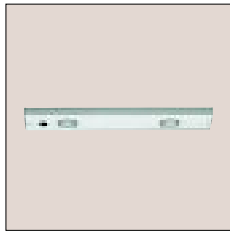

*blanc, white, wit, bianco, weiß*

|             |             |   |   |   |        |         |
|-------------|-------------|---|---|---|--------|---------|
| 60VA, 2x10W | 450x24x80mm | - | ✓ | 1 | 984.91 | 98491.8 |
| 60VA, 2x20W | 600x24x80mm | - | ✓ | 1 | 984.92 | 98492.5 |
| 60VA, 3x20W | 900x24x80mm | - | ✓ | 1 | 984.93 | 98493.2 |

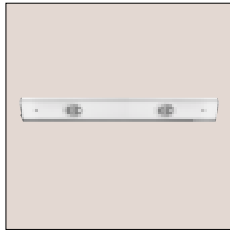

*blanc, white, wit, bianco, weiß*

|             |             |   |   |   |        |         |
|-------------|-------------|---|---|---|--------|---------|
| 60VA, 2x20W | 543x67x23mm | - | ✓ | 1 | 984.89 | 98494.9 |
| 60VA, 3x20W | 790x67x23mm | - | ✓ | 1 | 984.90 | 98490.1 |

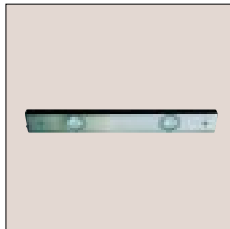

*acier brossé, brushed iron, staal geborsteld, ferro spazzolato, Eisen gebürstet*

|             |             |   |   |   |        |         |
|-------------|-------------|---|---|---|--------|---------|
| 60VA, 2x20W | 543x67x23mm | - | ✓ | 1 | 984.86 | 98486.4 |
| 60VA, 3x20W | 790x67x23mm | - | ✓ | 1 | 984.94 | 98420.8 |

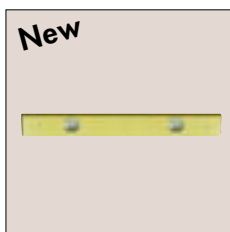

**New**

*laiton brossé, Brushed brass, Messing geborsteld, ottone spazzolato, Messing gebürstet*

|             |             |       |   |   |        |         |
|-------------|-------------|-------|---|---|--------|---------|
| 60VA, 2x20W | 543x67x23mm | 2x20W | ✓ | 1 | 984.57 | 98457.4 |
| 60VA, 3x20W | 790x67x23mm | 3x20W | ✓ | 1 | 984.55 | 98455.0 |



**Prise adaptable aux appliques placard 984.91 / 984.92 / 984.93**  
**Socket for Under-Cabinet Light 984.91 / 984.92 / 984.93**  
**contactdoos, voor keukenarmaturen 984.91 / 984.92 / 984.93**  
**Presà di corrente per lampade da installare sotto armadietti/scaffali 984.91 / 984.92 / 984.93**  
**Steckdose, zur Unterschrankleuchten 984.91 / 984.92 / 984.93**



*blanc, white, wit, bianco, weiß*

|   |             |   |   |   |        |         |
|---|-------------|---|---|---|--------|---------|
| - | 24x80x150mm | - | ✓ | 1 | 984.96 | 98496.3 |
|---|-------------|---|---|---|--------|---------|

**Connexion d'angle pour applique placard 984.91 / 984.92 / 984.93**  
**Connection for under-cabinet luminaires 984.91 / 984.92 / 984.93**  
**koppelstuk voor keukenarmaturen 984.91 / 984.92 / 984.93**  
**Collegamento ad angolo per lampade da installare sotto armadietti/ripiani 984.91 / 984.92 / 984.93**  
**Eckverbindung für Unterschrankleuchten 984.91 / 984.92 / 984.93**

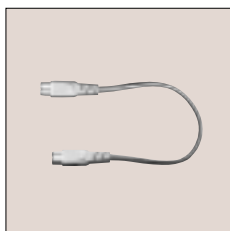

*blanc, white, wit, bianco, weiß*

|   |       |   |   |   |        |         |
|---|-------|---|---|---|--------|---------|
| - | 200mm | - | ✓ | 1 | 984.97 | 98497.0 |
|---|-------|---|---|---|--------|---------|

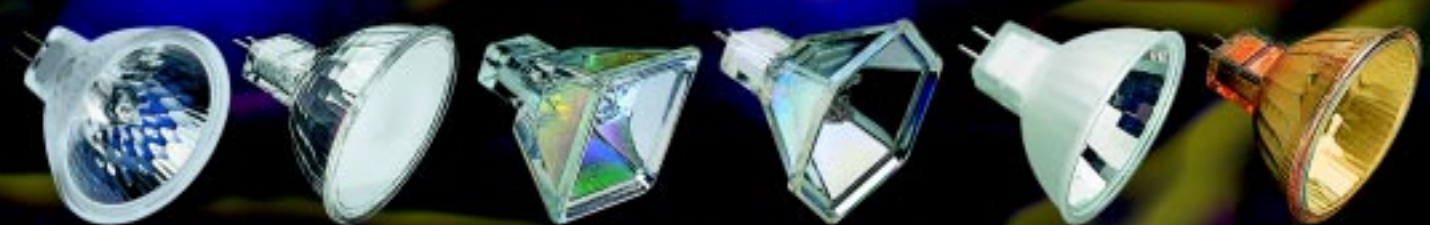
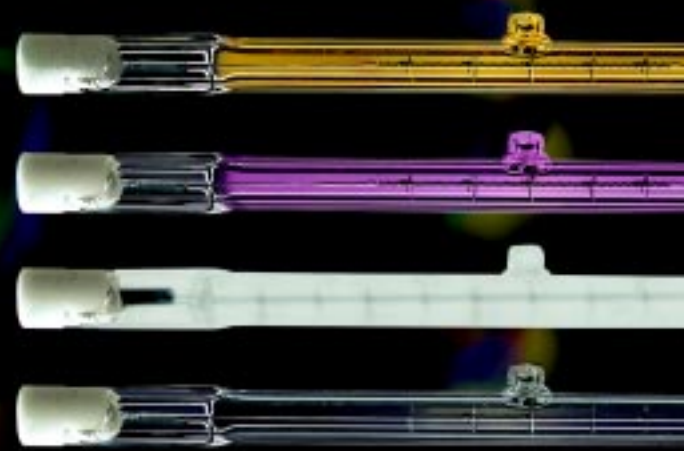



**Bi-pin halogène 12V**  
**12V Halogen Capsule**  
**halogeen steeklampje 12V**  
**Lampadina alogena bispina 12V**  
**Halogen-Stiftsockel 12V**

**G4** **ø9mm****1.000h****TIP***clair, clear, helder, chiaro, klar*

|       |      |   |    |        |         |
|-------|------|---|----|--------|---------|
| 4x10W | 33mm | ✓ | 10 | 843.14 | 84314.7 |
| 4x20W | 33mm | ✓ | 10 | 843.24 | 84324.6 |

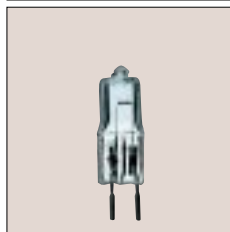
**G4** **ø9mm****1.000h****TIP***clair, clear, helder, chiaro, klar*

|     |      |  |    |        |         |
|-----|------|--|----|--------|---------|
| 10W | 33mm |  | 25 | 840.10 | 84010.8 |
| 20W | 33mm |  | 25 | 840.20 | 84020.7 |

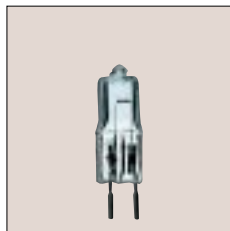
**G4** **ø9mm****1.500h****ECO***clair, clear, helder, chiaro, klar*

|     |      |  |    |        |         |
|-----|------|--|----|--------|---------|
| 10W | 33mm |  | 25 | 830.10 | 83010.9 |
| 20W | 33mm |  | 25 | 830.20 | 83020.8 |

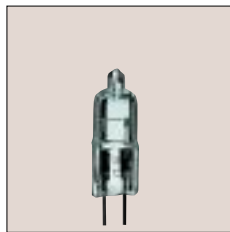
**G4** **ø9mm****2.000h***clair, clear, helder, chiaro, klar*

|    |      |   |    |         |         |
|----|------|---|----|---------|---------|
| 5W | 33mm |   | 10 | 831.05  | 83105.2 |
| 5W | 33mm | ✓ | 10 | 831.059 | 00361.9 |

**G4** **ø9mm****2.000h***clair, clear, helder, chiaro, klar*

|     |      |   |    |         |         |
|-----|------|---|----|---------|---------|
| 10W | 33mm |   | 10 | 831.10  | 83110.6 |
| 10W | 33mm | ✓ | 10 | 831.109 | 00362.6 |
| 20W | 33mm |   | 10 | 831.20  | 83120.5 |
| 20W | 33mm | ✓ | 10 | 831.209 | 00365.7 |
| 35W | 33mm |   | 10 | 831.35  | 83135.9 |



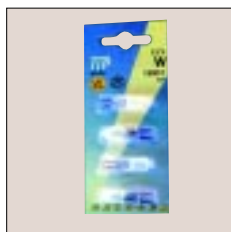

**Bi-pin halogène 12V**  
**12V Halogen Capsule**  
**halogeen steeklampje 12V**  
**Lampadina alogena bispina 12V**  
**Halogen-Stiftsockel 12V**

**G4****ø9mm****1.000h****TIP***satin, satin, satijn, satinato, satin*

|       |      |   |    |        |         |
|-------|------|---|----|--------|---------|
| 4x10W | 33mm | ✓ | 10 | 843.91 | 84391.8 |
| 4x20W | 33mm | ✓ | 10 | 843.92 | 84392.5 |

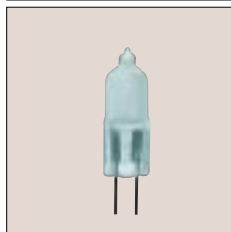
**G4****ø9mm****1.000h****TIP***satin, satin, satijn, satinato, satin*

|     |      |  |    |        |         |
|-----|------|--|----|--------|---------|
| 10W | 33mm |  | 25 | 843.93 | 84393.2 |
| 20W | 33mm |  | 25 | 843.94 | 84394.9 |
| 35W | 33mm |  | 25 | 843.95 | 84395.6 |

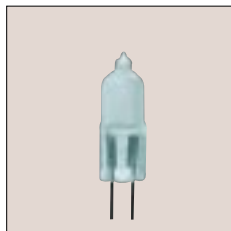
**G4****ø9mm****2.000h***satin, satin, satijn, satinato, satin*

|    |      |   |    |         |         |
|----|------|---|----|---------|---------|
| 5W | 33mm | ✓ | 10 | 831.052 | 00744.0 |
|----|------|---|----|---------|---------|

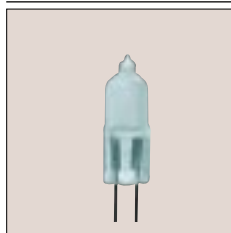
**G4****ø9mm****2.000h***satin, satin, satijn, satinato, satin*

|     |      |   |    |         |         |
|-----|------|---|----|---------|---------|
| 10W | 33mm |   | 10 | 831.12  | 83112.0 |
| 10W | 33mm | ✓ | 10 | 831.129 | 00364.0 |
| 20W | 33mm |   | 10 | 831.22  | 83122.9 |
| 20W | 33mm | ✓ | 10 | 831.229 | 00368.8 |

**G4****ø9mm****2.000h***rosé, rosé, roze, rosato, rosé*

|     |      |   |    |         |         |
|-----|------|---|----|---------|---------|
| 20W | 33mm | ✓ | 10 | 831.219 | 00367.1 |
|-----|------|---|----|---------|---------|

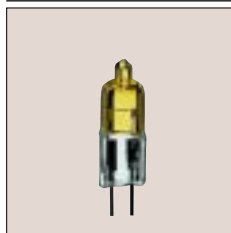
**G4****ø9mm****2.000h***doré, gold, goud, dorato, gold*

|    |      |   |    |         |         |
|----|------|---|----|---------|---------|
| 5W | 33mm | ✓ | 10 | 831.057 | 00573.6 |
|----|------|---|----|---------|---------|

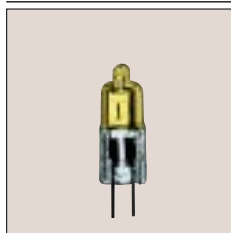
**G4****ø9mm****2.000h***doré, gold, goud, dorato, gold*

|     |      |   |    |         |         |
|-----|------|---|----|---------|---------|
| 10W | 33mm | ✓ | 10 | 831.179 | 00363.3 |
| 20W | 33mm | ✓ | 10 | 831.279 | 00366.4 |



**Bi-pin halogène 12V**  
**12V Halogen Capsule**  
**halogeen steeklampje 12V**  
**Lampadina alogena bispina 12V**  
**Halogen-Stiftsockel 12V**

**GY6,35 ø12mm**

1.000h

TIP

*clair, clear, helder, chiaro, klar*

|       |      |   |    |        |         |
|-------|------|---|----|--------|---------|
| 4x35W | 44mm | ✓ | 10 | 843.34 | 84334.5 |
| 4x50W | 44mm | ✓ | 10 | 843.54 | 84354.3 |

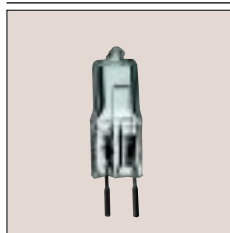
**GY6,35 ø12mm**

1.000h

TIP

*clair, clear, helder, chiaro, klar*

|     |      |  |    |        |         |
|-----|------|--|----|--------|---------|
| 35W | 44mm |  | 25 | 840.30 | 84030.6 |
| 50W | 44mm |  | 25 | 840.50 | 84050.4 |

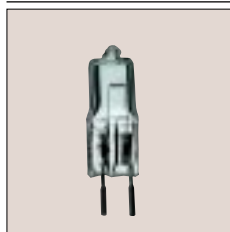
**GY6,35 ø12mm**

1.500h

ECO

*clair, clear, helder, chiaro, klar*

|     |      |  |    |        |         |
|-----|------|--|----|--------|---------|
| 35W | 44mm |  | 25 | 830.30 | 83030.7 |
| 50W | 44mm |  | 25 | 830.50 | 83050.5 |

**GY6,35 ø12mm**

2.000h

*clair, clear, helder, chiaro, klar*

|      |      |   |    |         |         |
|------|------|---|----|---------|---------|
| 20W  | 44mm |   | 10 | 831.25  | 83125.0 |
| 20W  | 44mm | ✓ | 10 | 831.259 | 00565.1 |
| 35W  | 44mm |   | 10 | 831.30  | 83130.4 |
| 35W  | 44mm | ✓ | 10 | 831.309 | 00369.5 |
| 50W  | 44mm |   | 10 | 831.50  | 83150.2 |
| 50W  | 44mm | ✓ | 10 | 831.509 | 00373.2 |
| 75W  | 44mm |   | 10 | 831.70  | 83170.0 |
| 100W | 44mm |   | 10 | 831.00  | 83100.7 |

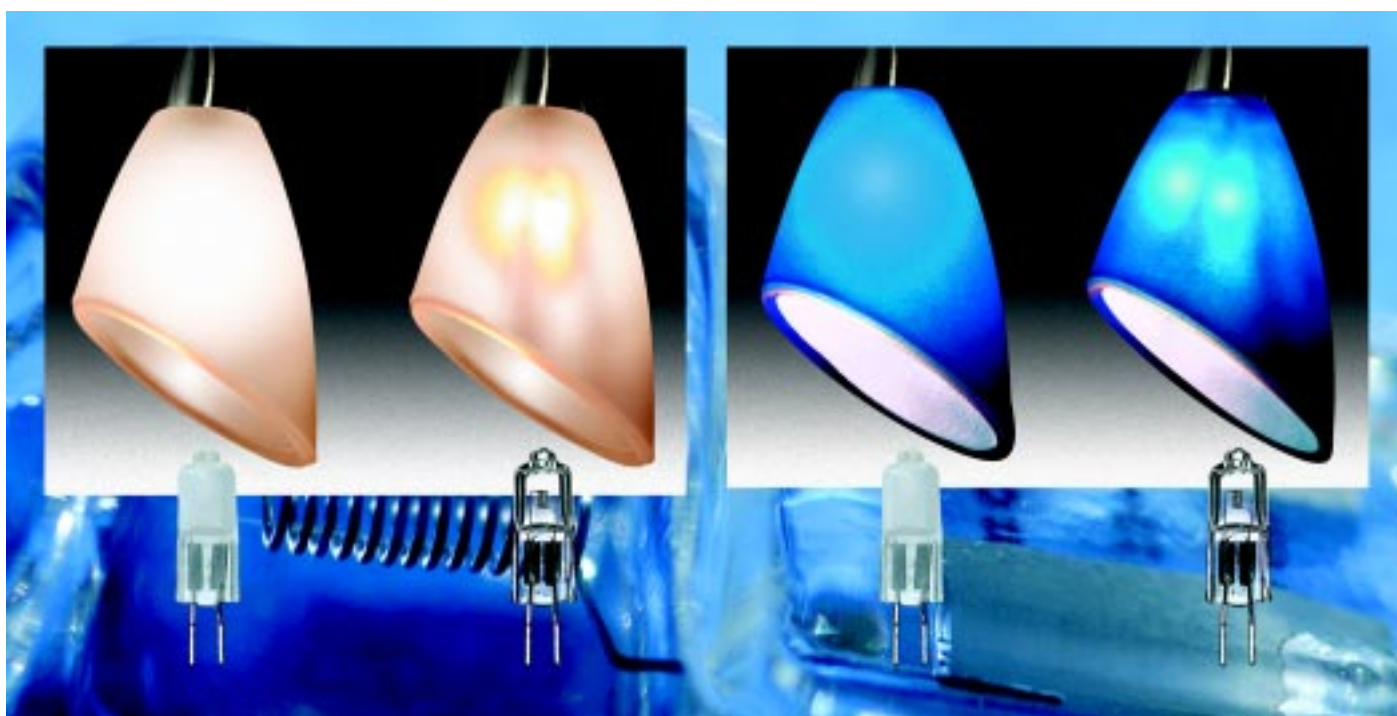



**Bi-pin halogène 12V**  
**12V Halogen Capsule**  
**halogeen steeklampje 12V**  
**Lampadina alogena bispina 12V**  
**Halogen-Stiftsockel 12V**



**GY6,35 ø12mm**  
*satin, satin, satijn, satinato, satin*

**1.000h**

**TIP**

|     |      |    |               |         |
|-----|------|----|---------------|---------|
| 35W | 44mm | 25 | <b>831.01</b> | 83101.4 |
| 50W | 44mm | 25 | <b>831.02</b> | 83102.1 |



**GY6,35 ø12mm**  
*satin, satin, satijn, satinato, satin*

**2.000h**



|     |      |   |    |                |         |
|-----|------|---|----|----------------|---------|
| 35W | 44mm | ✓ | 10 | <b>831.32</b>  | 83132.8 |
| 50W | 44mm | ✓ | 10 | <b>831.529</b> | 00376.3 |



**GY6,35 ø12mm**  
*doré, gold, goud, dorato, gold*

**2.000h**



|     |      |   |    |                |         |
|-----|------|---|----|----------------|---------|
| 20W | 44mm | ✓ | 10 | <b>831.257</b> | 83124.3 |
| 35W | 44mm | ✓ | 10 | <b>831.379</b> | 00370.1 |
| 50W | 44mm | ✓ | 10 | <b>831.579</b> | 00374.9 |



**GY6,35 ø12mm**  
*rosé, rosé, roze, rosato, rosé*

**2.000h**



|     |      |   |    |                |         |
|-----|------|---|----|----------------|---------|
| 50W | 44mm | ✓ | 10 | <b>831.519</b> | 00375.6 |
|-----|------|---|----|----------------|---------|





**Bi-pin halogène 6V, avec filament transversal**  
**6V halogen capsule with transversal filament**  
**6V halogeen steeklampje**  
**Lampadina alogena bispina 6V, con filamento trasversale**  
**6V Halogen-Stiftsockel, mit Transversalwendel**

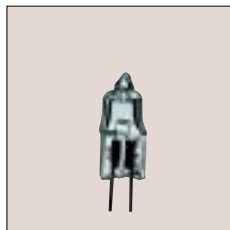

**G4** **ø9mm** **1.500h**

*clair, clear, helder, chiaro, klar*

|     |      |    |        |         |
|-----|------|----|--------|---------|
| 10W | 33mm | 10 | 839.10 | 83910.2 |
| 20W | 33mm | 10 | 839.20 | 83920.1 |

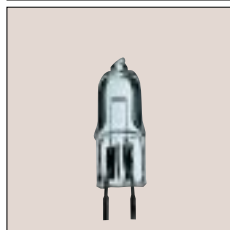

**GY6,35** **ø12mm** **1.500h**

*clair, clear, helder, chiaro, klar*

|     |      |    |        |         |
|-----|------|----|--------|---------|
| 35W | 44mm | 10 | 839.30 | 83930.0 |
|-----|------|----|--------|---------|

**Bi-pin halogène 24V, avec filament transversal**  
**24V halogen capsule with transversal filament**  
**24V halogeen steeklampje**  
**Lampadina alogena bispina 24V, con filamento trasversale**  
**24V Halogen-Stiftsockel, mit Transversalwendel**

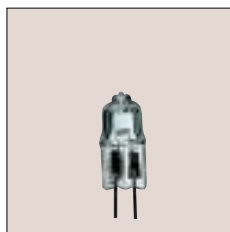

**G4** **ø9mm** **2.000h**

*clair, clear, helder, chiaro, klar*

|     |      |    |        |         |
|-----|------|----|--------|---------|
| 20W | 33mm | 10 | 831.26 | 83126.7 |
|-----|------|----|--------|---------|

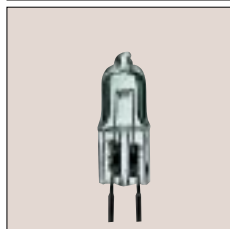

**GY6,35** **ø12mm** **2.000h**

*clair, clear, helder, chiaro, klar*

|      |      |    |        |         |
|------|------|----|--------|---------|
| 50W  | 44mm | 10 | 831.56 | 83156.4 |
| 100W | 44mm | 10 | 831.06 | 83106.9 |





**Miniglobe halogène 12V**  
**Halogen Miniglobe 12V**  
**halogeen miniglobe 12V**  
**Lampadina alogena Miniglobe 12V**  
**Halogen-Miniglobe 12V**



**G4** **ø45mm** **2.000h**

*soft-opale, soft opal, softopaal, opale tenue, softopal*

*Soft Opal*

|     |      |   |    |               |         |
|-----|------|---|----|---------------|---------|
| 10W | 65mm | ✓ | 10 | <b>829.17</b> | 82917.2 |
| 20W | 65mm | ✓ | 10 | <b>829.27</b> | 82927.1 |



**G4** **ø45mm** **2.000h**

*granité clair, ice-crystal clear, IJskristal helder, cristalli di ghiaccio chiaro, Eiskristall klar*

|     |      |   |    |               |         |
|-----|------|---|----|---------------|---------|
| 10W | 65mm | ✓ | 10 | <b>829.14</b> | 82914.1 |
| 20W | 65mm | ✓ | 10 | <b>829.24</b> | 82924.0 |



**G4** **ø60mm** **2.000h**

*soft-opale, soft opal, softopaal, opale tenue, softopal*

*Soft Opal*

|     |      |   |    |               |         |
|-----|------|---|----|---------------|---------|
| 20W | 78mm | ✓ | 10 | <b>829.54</b> | 82954.7 |
| 35W | 78mm | ✓ | 10 | <b>829.55</b> | 82955.4 |

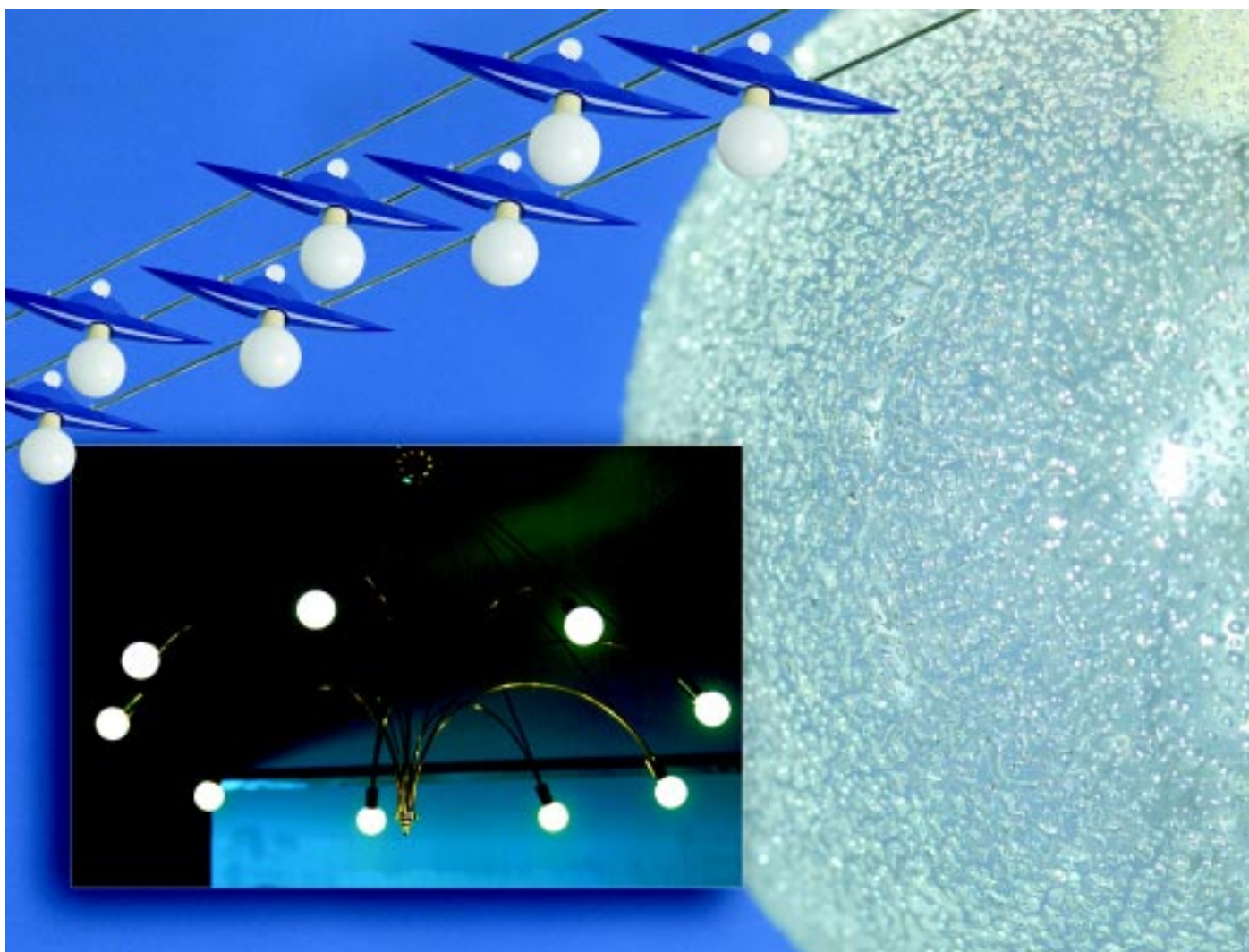



**Cosyball halogène 12V**  
**Halogen Cosyball 12V**  
**Halogen-Cosyball 12V**  
**Lampadina alogena Cosyball 12V**  
**Halogen-Cosyball 12V**

**G4****ø45mm****2.000h***soft-opale, soft opal, softopaal, opale tenue, softopal**Soft Opal*

|     |      |    |        |         |
|-----|------|----|--------|---------|
| 10W | 89mm | 10 | 829.30 | 82930.1 |
| 20W | 89mm | 10 | 829.31 | 82931.8 |

**G4****ø45mm****2.000h***satin, satin, satijn, satinato, satin*

|     |      |    |        |         |
|-----|------|----|--------|---------|
| 10W | 89mm | 10 | 829.33 | 82933.2 |
| 20W | 89mm | 10 | 829.34 | 82934.9 |

**Cosylight halogène 12V**  
**Halogen Cosylight 12V**  
**Halogen-Cosylight 12V**  
**Lampadina alogena Cosylight 12V**  
**Halogen-Cosylight 12V**

**G4****ø35mm****2.000h***soft-opale, soft opal, softopaal, opale tenue, softopal**Soft Opal*

|     |       |    |        |         |
|-----|-------|----|--------|---------|
| 10W | 120mm | 10 | 829.42 | 82942.4 |
| 20W | 120mm | 10 | 829.43 | 82943.1 |





**Dichroïque halogène 12V, fermée**  
**halogen dichroic 12V lamp, with front-glass**  
**Halogeen-koudlichtspiegel 12V, met frontglas**  
**Dicroica 12V, con vetro di protezione**  
**Halogen-Kaltlichtspiegel 12V, mit Schutzglas**

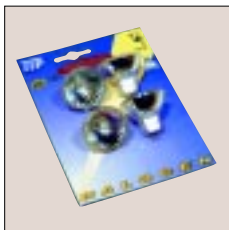

**GU4** **ø35mm (MR11)** **1.000h**

*argent, silver, zilver, argentato, silber*

|       |      |               |   |    |        |         |
|-------|------|---------------|---|----|--------|---------|
| 4x20W | 35mm | FTD flood 30° | ✓ | 10 | 842.14 | 84214.0 |
|-------|------|---------------|---|----|--------|---------|

TIP



**GU4** **ø35mm (MR11)** **1.000h**

*argent, silver, zilver, argentato, silber*

|     |      |               |  |    |        |         |
|-----|------|---------------|--|----|--------|---------|
| 20W | 35mm | FTD flood 30° |  | 20 | 840.27 | 84027.6 |
|-----|------|---------------|--|----|--------|---------|

|     |      |               |  |    |        |         |
|-----|------|---------------|--|----|--------|---------|
| 35W | 35mm | FTH flood 30° |  | 20 | 840.37 | 84037.5 |
|-----|------|---------------|--|----|--------|---------|

TIP



**GU4** **ø35mm (MR11)** **1.500h**

*argent, silver, zilver, argentato, silber*

|     |      |               |  |    |        |         |
|-----|------|---------------|--|----|--------|---------|
| 20W | 35mm | FTD flood 30° |  | 25 | 830.27 | 83027.7 |
|-----|------|---------------|--|----|--------|---------|

|     |      |               |  |    |        |         |
|-----|------|---------------|--|----|--------|---------|
| 35W | 35mm | FTH flood 30° |  | 25 | 830.37 | 83037.6 |
|-----|------|---------------|--|----|--------|---------|

ECO

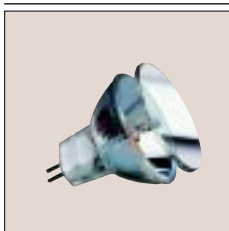

**GU4** **ø35mm (MR11)** **2.000h**

*argent, silver, zilver, argentato, silber*

|    |      |           |   |    |        |         |
|----|------|-----------|---|----|--------|---------|
| 5W | 35mm | flood 38° | ✓ | 10 | 838.09 | 83809.9 |
|----|------|-----------|---|----|--------|---------|

|     |      |           |   |    |        |         |
|-----|------|-----------|---|----|--------|---------|
| 10W | 35mm | flood 30° | ✓ | 10 | 838.19 | 83819.8 |
|-----|------|-----------|---|----|--------|---------|

|     |      |               |   |    |          |         |
|-----|------|---------------|---|----|----------|---------|
| 20W | 35mm | FTD flood 38° | ✓ | 10 | 8838.299 | 00847.8 |
|-----|------|---------------|---|----|----------|---------|

|     |      |               |   |    |          |         |
|-----|------|---------------|---|----|----------|---------|
| 35W | 35mm | FTH flood 38° | ✓ | 10 | 8838.399 | 00848.5 |
|-----|------|---------------|---|----|----------|---------|



**Réflecteur halogène Security 12V, fermée**  
**12V Security halogen reflector lamp, with front-glass**  
**Security Halogeen reflectorlamp 12V, met frontglas**  
**Riflettore alogeno Security 12V, con vetro di protezione**  
**Security Halogen-Reflektorlampe 12V, mit Schutzglas**

**SECURITY**

**GU4** **ø35mm (MR11)** **1.000h**

*argent, silver, zilver, argentato, silber*

|     |      |               |  |    |        |         |
|-----|------|---------------|--|----|--------|---------|
| 20W | 35mm | FTD flood 30° |  | 25 | 822.20 | 82220.3 |
|-----|------|---------------|--|----|--------|---------|

|     |      |               |  |    |        |         |
|-----|------|---------------|--|----|--------|---------|
| 35W | 35mm | FTH flood 30° |  | 25 | 822.30 | 82230.2 |
|-----|------|---------------|--|----|--------|---------|

**SECURITY**

**GU4** **ø35mm (MR11)** **2.000h**

*argent, silver, zilver, argentato, silber*

|     |      |               |   |    |        |         |
|-----|------|---------------|---|----|--------|---------|
| 20W | 38mm | FTD flood 30° | ✓ | 10 | 822.21 | 82221.0 |
|-----|------|---------------|---|----|--------|---------|

|     |      |               |   |    |        |         |
|-----|------|---------------|---|----|--------|---------|
| 35W | 38mm | FTH flood 30° | ✓ | 10 | 822.31 | 82231.9 |
|-----|------|---------------|---|----|--------|---------|

**SECURITY**

**SECURITY**  
**ALUMINIUM REFLECTOR**  
 Wärmeverteilung  
 Répartition de la chaleur  
 Heat distribution

**COOL** 20% **HOT** 80%



**Dichroïque halogène 12V ouverte**  
**Halogen Dichroic lamp 12V, without front-glass**  
**halogeen koudlichtspiegel, zonder frontglas**  
**Dicroica 12V, senza vetro di protezione**  
**Halogen-Kaltlichtspiegel 12V, ohne Schutzglas**



**GU4** **ø35mm** (MR11) **2.000h**

*rosé, rosé, roze, rosato, rosé*

|     |      |               |   |    |         |         |
|-----|------|---------------|---|----|---------|---------|
| 20W | 35mm | FTD flood 38° | ✓ | 10 | 838.291 | 00540.8 |
| 35W | 35mm | FTH flood 38° | ✓ | 10 | 838.391 | 00546.0 |

**Dichroïque halogène 2000 12V, fermée**  
**12V halogen 2000 dichroic lamp, with front-glass**  
**Halogeen 2000 koudlichtspiegel 12V, met frontglas**  
**Dicroica 2000 12V, con vetro di protezione**  
**Halogen-2000-Kaltlichtspiegel 12V, mit Schutzglas**



**GU4** **ø35mm** (MR11) **2.000h**

*doré, gold, goud, dorato, gold*

|     |      |               |   |    |          |         |
|-----|------|---------------|---|----|----------|---------|
| 20W | 35mm | FTD flood 38° | ✓ | 10 | 8838.297 | 00553.8 |
| 35W | 35mm | FTH flood 38° | ✓ | 10 | 8838.397 | 00559.0 |

**Dichroïque Joyau 12V fermée**  
**Halogen 12V Jewel Dichroic Lamp, with front-glass**  
**Juwel halogeen koudlichtspiegel, met frontglas**  
**Dicroica Juwel 12V, con vetro di protezione**  
**Juwel Halogen-Kaltlichtspiegel 12V, mit Schutzglas**

**JUWEL**



**GU4** **ø35mm** (MR11) **2.000h**

*satin, satin, satijn, satinato, satin*

|     |      |               |   |    |        |         |
|-----|------|---------------|---|----|--------|---------|
| 20W | 35mm | FTD flood 38° | ✓ | 10 | 838.21 | 83821.1 |
| 35W | 35mm | FTH flood 38° | ✓ | 10 | 838.31 | 83831.0 |

**Lampe Akzent halogène à réflecteur métalisé 12V fermée**  
**Akzent halogen reflector lamp, with front glass**  
**halogeen akzentlampen 12V, met frontglas**  
**Riflettore alogeno Akzent 12V, con vetro di protezione**  
**Akzent-Halogen-Reflektorlampe 12V, mit Schutzglas**

**Akzent**

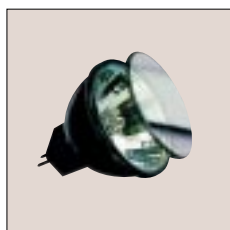

**GU4** **ø35mm** (MR11) **2.000h**

*noir, black, zwart, nero, schwarz*

|     |      |               |   |    |        |         |
|-----|------|---------------|---|----|--------|---------|
| 20W | 35mm | FTD flood 38° | ✓ | 10 | 822.24 | 82224.1 |
| 35W | 35mm | FTH flood 38° | ✓ | 10 | 822.32 | 82232.6 |

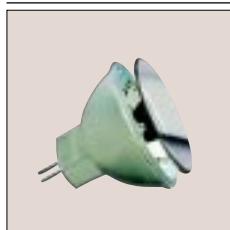

**GU4** **ø35mm** (MR11) **2.000h**

*alu brossé, alu matt, alu mat, color alluminio opaco, alu matt*

|     |      |               |   |    |        |         |
|-----|------|---------------|---|----|--------|---------|
| 20W | 35mm | FTD flood 38° | ✓ | 10 | 822.26 | 82226.5 |
| 35W | 35mm | FTH flood 38° | ✓ | 10 | 822.33 | 82233.3 |



Lampe Akzent halogène à réflecteur métalisé 12V fermée  
 Akzent halogen reflector lamp, with front glass  
 halogeen akzentlampen 12V, met frontglas  
 Riflettore alogeno Akzent 12V, con vetro di protezione  
 Akzent-Halogen-Reflektorlampe 12V, mit Schutzglas

Akzent



**GU4** **ø35mm** (MR11) **2.000h**

*doré, gold, goud, dorato, gold*

|     |      |               |   |    |        |         |
|-----|------|---------------|---|----|--------|---------|
| 20W | 35mm | FTD flood 38° | ✓ | 10 | 822.27 | 82227.2 |
|-----|------|---------------|---|----|--------|---------|



**GU4** **ø35mm** (MR11) **2.000h**

*argent, silver, zilver, argentato, silber*

|     |      |               |   |    |        |         |
|-----|------|---------------|---|----|--------|---------|
| 20W | 35mm | FTD flood 38° | ✓ | 10 | 822.29 | 82229.6 |
| 35W | 35mm | FTH flood 38° | ✓ | 10 | 822.39 | 82239.5 |



Halogène-Maxiflood a réflecteur 12V, fermée  
 Halogen Maxiflood reflector lamp 12V, with front glass  
 halogeen Maxiflood reflectorlamp 12V, met front  
 Riflettore alogeno Maxiflood 12V, con vetro di protezione  
 Halogen-Maxiflood-Reflektorlampe 12V, mit Schutzglas

MAXI FLOOD



**GU4** **ø35mm** (MR11) **1.500h**

*soft-opale, soft opal, softopaal, opale tenue, softopal*

|     |      |                |   |    |        |         |
|-----|------|----------------|---|----|--------|---------|
| 20W | 35mm | maxiflood 100° | ✓ | 10 | 822.22 | 82222.7 |
| 35W | 35mm | maxiflood 100° | ✓ | 10 | 822.23 | 82223.4 |





**Dichroïque halogène 12V ouverte**  
**12V halogen dichroic lamp, without front glass**  
**Halogeen koudlichtspiegel, zonder frontglas**  
**Dicroica 12V, senza vetro di protezione**  
**Halogen-Kaltlichtspiegel 12V, ohne Schutzglas**



**GU5,3 ø51mm (MR16) 2.000h**

argent, silver, zilver, argentato, silber

|     |      |               |    |               |         |
|-----|------|---------------|----|---------------|---------|
| 20W | 45mm | BAB flood 38° | 25 | <b>830.25</b> | 83025.3 |
| 35W | 45mm | FMW flood 38° | 25 | <b>830.35</b> | 83035.2 |
| 50W | 45mm | EXN flood 38° | 25 | <b>830.55</b> | 83055.0 |

ECO



**GU5,3 ø51mm (MR16) 4.000h**

argent, silver, zilver, argentato, silber

|     |      |               |   |    |                |         |
|-----|------|---------------|---|----|----------------|---------|
| 20W | 45mm | BAB flood 38° | ✓ | 10 | <b>833.299</b> | 00387.9 |
| 35W | 45mm | FMW flood 38° | ✓ | 10 | <b>833.399</b> | 00390.9 |
| 50W | 45mm | EXN flood 38° | ✓ | 10 | <b>833.599</b> | 00393.0 |

**Dichroïque halogène 12V, fermée**  
**halogen dichroic 12V lamp, with front-glass**  
**Halogeen-koudlichtspiegel 12V, met frontglas**  
**Dicroica 12V, con vetro di protezione**  
**Halogen-Kaltlichtspiegel 12V, mit Schutzglas**

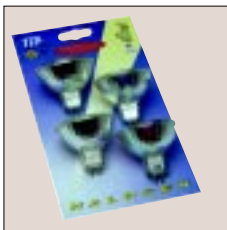

**GU5,3 ø51mm (MR16) 1.000h**

argent, silver, zilver, argentato, silber

|       |      |               |   |    |               |         |
|-------|------|---------------|---|----|---------------|---------|
| 4x20W | 45mm | BAB flood 38° | ✓ | 10 | <b>842.24</b> | 84224.9 |
| 4x35W | 45mm | FMW flood 38° | ✓ | 10 | <b>842.34</b> | 84234.8 |
| 4x50W | 45mm | EXN flood 38° | ✓ | 10 | <b>842.54</b> | 84254.6 |

TTP



**GU5,3 ø51mm (MR16) 1.000h**

argent, silver, zilver, argentato, silber

|     |      |               |  |    |               |         |
|-----|------|---------------|--|----|---------------|---------|
| 20W | 45mm | BAB flood 38° |  | 20 | <b>840.26</b> | 84026.9 |
| 35W | 45mm | FMW flood 38° |  | 20 | <b>840.36</b> | 84036.8 |
| 50W | 45mm | EXN flood 38° |  | 20 | <b>840.56</b> | 84056.6 |

TTP



**GU5,3 ø51mm (MR16) 2.000h**

argent, silver, zilver, argentato, silber

|     |      |               |  |    |               |         |
|-----|------|---------------|--|----|---------------|---------|
| 20W | 45mm | BAB flood 38° |  | 25 | <b>830.26</b> | 83026.0 |
| 35W | 45mm | FMW flood 38° |  | 25 | <b>830.36</b> | 83036.9 |
| 50W | 45mm | EXN flood 38° |  | 25 | <b>830.56</b> | 83056.7 |

ECO



**GU5,3 ø51mm (MR16) 2.000h**

argent, silver, zilver, argentato, silber

|     |      |               |   |    |                |         |
|-----|------|---------------|---|----|----------------|---------|
| 5W  | 45mm | flood 38°     |   | 10 | <b>833.05</b>  | 83305.6 |
| 10W | 45mm | flood 38°     |   | 10 | <b>833.19</b>  | 00747.1 |
| 10W | 45mm | flood 38°     | ✓ | 10 | <b>833.199</b> | 00746.4 |
| 20W | 45mm | BAB flood 38° | ✓ | 10 | <b>833.72</b>  | 83372.8 |
| 35W | 45mm | FMW flood 38° | ✓ | 10 | <b>833.73</b>  | 83373.5 |
| 50W | 45mm | EXN flood 38° | ✓ | 10 | <b>833.75</b>  | 83375.9 |



**Dichroïque halogène 12V, fermée**  
**halogen dichroic 12V lamp, with front-glass**  
**Halogeen-koudlichtspiegel 12V, met frontglas**  
**Dicroica 12V, con vetro di protezione**  
**Halogen-Kaltlichtspiegel 12V, mit Schutzglas**



**GU5,3** **ø51mm (MR16)** **4.000h**

*argent, silver, zilver, argentato, silber*

|     |      |                   |   |    |          |         |
|-----|------|-------------------|---|----|----------|---------|
| 20W | 45mm | ESX spot 10°      | ✓ | 10 | 8833.209 | 00315.2 |
| 20W | 45mm | BBF medium 20°    | ✓ | 10 | 8833.289 | 00316.9 |
| 20W | 45mm | BAB flood 38°     |   | 10 | 8833.29  | 00803.4 |
| 20W | 45mm | BAB flood 38°     | ✓ | 10 | 8833.299 | 00317.6 |
| 20W | 45mm | superflood 60°    |   | 10 | 8833.25  | 00852.2 |
| 35W | 45mm | FRB spot 10°      | ✓ | 10 | 8833.309 | 00318.3 |
| 35W | 45mm | FRA medium 20°    | ✓ | 10 | 8833.389 | 00319.0 |
| 35W | 45mm | FMW flood 38°     |   | 10 | 8833.39  | 00806.5 |
| 35W | 45mm | FMW flood 38°     | ✓ | 10 | 8833.399 | 00320.6 |
| 35W | 45mm | superflood 60°    |   | 10 | 8833.35  | 00851.5 |
| 50W | 45mm | EXT spot 10°      | ✓ | 10 | 8833.509 | 00321.3 |
| 50W | 45mm | EXZ medium 20°    | ✓ | 10 | 8833.589 | 00322.0 |
| 50W | 45mm | EXN flood 38°     |   | 10 | 8833.59  | 00809.6 |
| 50W | 45mm | EXN flood 38°     | ✓ | 10 | 8833.599 | 00323.7 |
| 50W | 45mm | FNVsuperflood 60° | ✓ | 10 | 8833.559 | 00324.4 |
| 75W | 45mm | EYC flood 38°     |   | 10 | 8833.79  | 00811.9 |

**Réflecteur halogène Security 12V, fermée**  
**12V Security halogen reflector lamp, with front-glass**  
**Security Halogeen reflectorlamp 12V, met frontglas**  
**Riflettore alogeno Security 12V, con vetro di protezione**  
**Security Halogen-Reflektorlampe 12V, mit Schutzglas**

**SECURITY**



**GU5,3** **ø51mm (MR16)** **2.000h**

*argent, silver, zilver, argentato, silber*

|     |      |               |  |    |        |         |
|-----|------|---------------|--|----|--------|---------|
| 20W | 45mm | BAB flood 38° |  | 25 | 832.20 | 83220.2 |
| 35W | 45mm | FMW flood 38° |  | 25 | 832.30 | 83230.1 |
| 50W | 45mm | EXN flood 38° |  | 25 | 832.50 | 83250.9 |

**SECURITY**



**GU5,3** **ø51mm (MR16)** **4.000h**

*argent, silver, zilver, argentato, silber*

|     |      |               |   |    |        |         |
|-----|------|---------------|---|----|--------|---------|
| 20W | 45mm | BAB flood 38° | ✓ | 10 | 832.21 | 83221.9 |
| 35W | 45mm | FMW flood 38° | ✓ | 10 | 832.31 | 83231.8 |
| 50W | 45mm | EXN flood 38° | ✓ | 10 | 832.51 | 83251.6 |

**SECURITY**

**SECURITY**

ALUMINIUM REFLECTOR



Wärmeverteilung  
 Répartition de la chaleur  
 Heat distribution

COOL  
 20%





**Dichroïque halogène 12V, fermée**  
**halogen dichroic 12V lamp, with front-glass**  
**Halogeen-koudlichtspiegel 12V, met frontglas**  
**Dicroica 12V, con vetro di protezione**  
**Halogen-Kaltlichtspiegel 12V, mit Schutzglas**



**GU5,3 ø51mm (MR16) 4.000h**

*rosé, rosé, roze, rosato, rosé*

|     |      |               |   |    |          |         |
|-----|------|---------------|---|----|----------|---------|
| 20W | 45mm | BAB flood 38° | ✓ | 10 | 8833.291 | 00829.4 |
| 35W | 45mm | FMW flood 38° | ✓ | 10 | 8833.391 | 00832.4 |
| 50W | 45mm | EXN flood 38° | ✓ | 10 | 8833.591 | 00835.5 |



**GU5,3 ø51mm (MR16) 4.000h**

*doré, gold, goud, dorato, gold*

|     |      |                   |   |    |          |         |
|-----|------|-------------------|---|----|----------|---------|
| 10W | 45mm | flood 38°         | ✓ | 10 | 833.197  | 00745.7 |
| 20W | 45mm | BAB flood 38°     | ✓ | 10 | 8833.297 | 00818.8 |
| 35W | 45mm | FMW flood 38°     | ✓ | 10 | 8833.397 | 00821.8 |
| 50W | 45mm | EXN flood 38°     | ✓ | 10 | 8833.597 | 00824.9 |
| 50W | 45mm | FNVsuperflood 60° | ✓ | 10 | 8833.557 | 00845.4 |

**Dichroïque halogène 12V verre dépoli fermée**  
**12V halogen dichroic matt-glass lamp, with front-glass**  
**halogeen koudlichtspiegel Mattglas, met frontglas**  
**Dicroica vetro opaco 12V, con vetro di protezione**  
**Halogen-Kaltlichtspiegel Mattglas 12V, mit Schutzglas**



**GU5,3 ø51mm (MR16) 4.000h**

*argent-dépoli, silver-matt, matzilver, argentato-opaco, silber-matt*

|     |      |               |   |    |        |         |
|-----|------|---------------|---|----|--------|---------|
| 20W | 45mm | BAB flood 38° | ✓ | 10 | 830.28 | 83028.4 |
| 35W | 45mm | FMW flood 38° | ✓ | 10 | 830.38 | 83038.3 |
| 50W | 45mm | EXN flood 38° | ✓ | 10 | 830.58 | 83058.1 |





**Dichroïque halogène Hightec 12V, fermée**  
**12V Hightec Halogen Dichroic Lamp, with front-glass**  
**Hightec Halogeen-koudlichtspiegel 12V, met frontglas**  
**Dicroica Hightec 12V, con vetro di protezione**  
**Hightec Halogen-Kaltlichtspiegel 12V, mit Schutzglas**

**HIGHTEC****GU5,3** **ø51mm (MR16)** **5.000h***argent, silver, zilver, argentato, silber*

|     |      |               |   |    |               |         |
|-----|------|---------------|---|----|---------------|---------|
| 20W | 45mm | BAB flood 38° | ✓ | 10 | <b>823.29</b> | 82329.3 |
| 35W | 45mm | FMW flood 38° | ✓ | 10 | <b>823.39</b> | 82339.2 |
| 50W | 45mm | EXN flood 38° | ✓ | 10 | <b>823.59</b> | 82359.0 |

**GU5,3** **ø51mm (MR16)** **10.000h***argent, silver, zilver, argentato, silber*

|     |      |               |   |    |               |         |
|-----|------|---------------|---|----|---------------|---------|
| 35W | 45mm | FMW flood 36° | ✓ | 10 | <b>823.93</b> | 82393.4 |
| 50W | 45mm | EXN flood 36° | ✓ | 10 | <b>823.95</b> | 82395.8 |

# HIGHTEC

**5000h**  
**10000h**

**1000h**  
**1500h**  
**2000h**  
**8000h**



**Dichroïque Joyau 12V fermée**  
**Halogen 12V Jewel Dichroic Lamp, with front-glass**  
**Juwel halogeen koudlichtspiegel, met frontglas**  
**Dicroica Juwel 12V, con vetro di protezione**  
**Juwel Halogen-Kaltlichtspiegel 12V, mit Schutzglas**

**JUWEL****GU5,3 ø51mm (MR16) 4.000h***satin-argent, satin-silver, satijn-zilver, satinato-argentato, satin-silber*

|     |      |               |   |    |        |         |
|-----|------|---------------|---|----|--------|---------|
| 20W | 45mm | BAB flood 38° | ✓ | 10 | 833.21 | 83321.6 |
| 35W | 45mm | FMW flood 38° | ✓ | 10 | 833.31 | 83331.5 |
| 50W | 45mm | EXN flood 38° | ✓ | 10 | 833.51 | 83351.3 |

**GU5,3 ø51mm (MR16) 4.000h***doré, gold, goud, dorato, gold*

|     |      |               |   |    |        |         |
|-----|------|---------------|---|----|--------|---------|
| 20W | 45mm | BAB flood 38° | ✓ | 10 | 833.27 | 83327.8 |
| 35W | 45mm | FMW flood 38° | ✓ | 10 | 833.37 | 83337.7 |
| 50W | 45mm | EXN flood 38° | ✓ | 10 | 833.57 | 83357.5 |

**Xenoncolor cool white, dichroïque halogène 12V, fermée**  
**Xenon color cool white, 12V halogen dichroic light, with front-glass**  
**Xenoncolor cool white, halogeen koudlichtspiegel 12V, met frontglas**  
**Xenoncolor cool white, dicroica 12V, con vetro di protezione**  
**Xenoncolor cool white, Halogen Kaltlichtspiegel 12V, mit Schutzglas**

**XENON  
COLOR****GU5,3 ø51mm (MR16) 4.000h***couleur xenon, xenon-colour, xenon-color, color xeno, xenon-color*

|     |      |               |   |    |        |         |
|-----|------|---------------|---|----|--------|---------|
| 50W | 45mm | EXN flood 36° | ✓ | 10 | 833.07 | 83307.0 |
|-----|------|---------------|---|----|--------|---------|

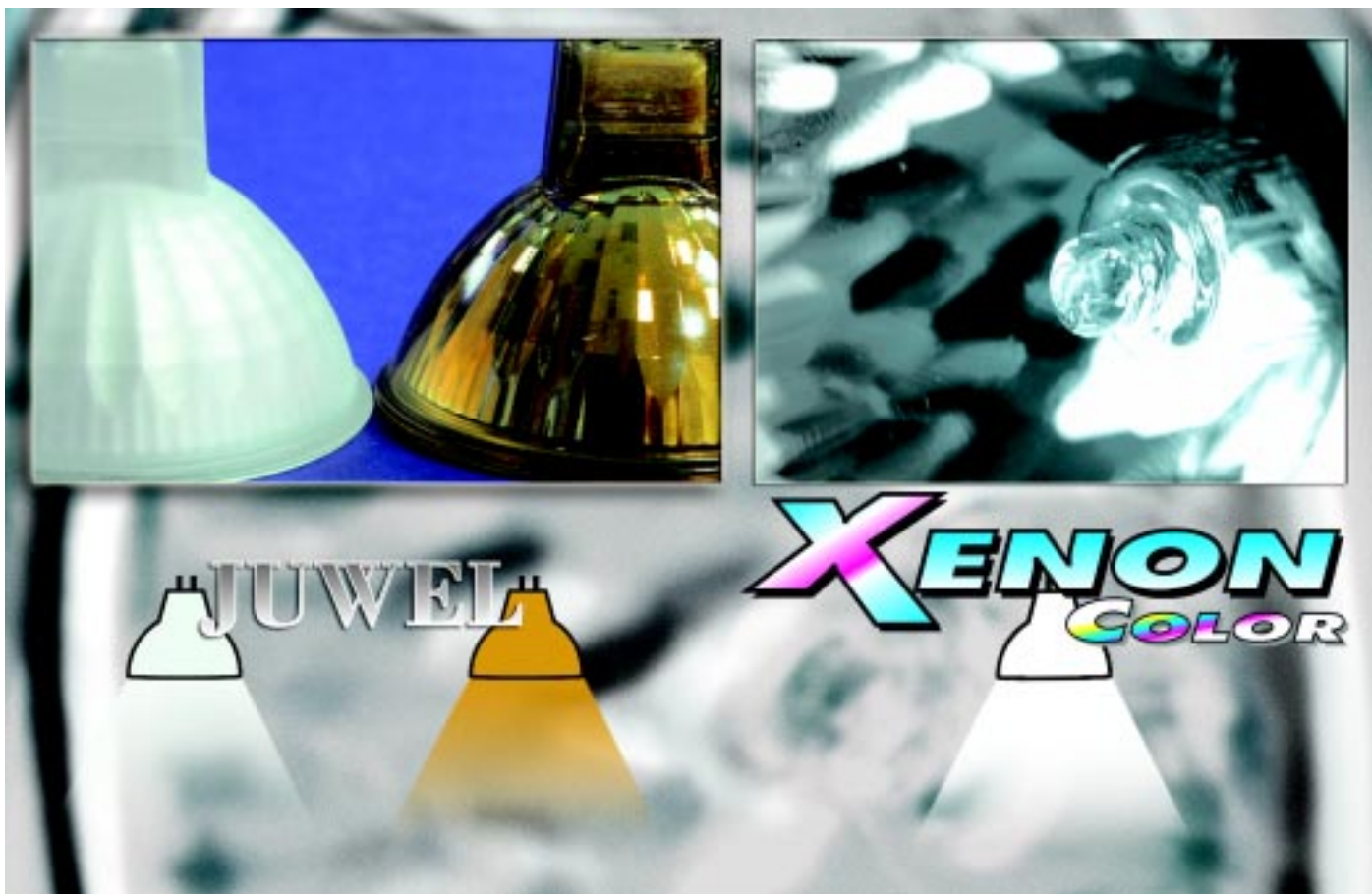

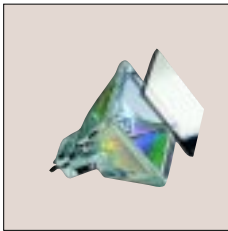

**Réflecteur halogène Quadro 12V fermée**  
**Quadro halogen reflector lamp 12V, with protective glass**  
**quadro halogeen-reflektorlamp 12V, met frontglas**  
**Riflettore alogeno Quadro 12V, con vetro di protezione**  
**Quadro Halogen-Reflektorlampe 12V, mit Schutzglas**

4  
**Quadro**

**GU5,3** **ø37x37mm** **1.500h**

*argent, silver, zilver, argentato, silber*

|     |      |           |   |    |        |         |
|-----|------|-----------|---|----|--------|---------|
| 20W | 45mm | flood 60° | ✓ | 10 | 833.45 | 83345.2 |
| 35W | 45mm | flood 60° | ✓ | 10 | 833.46 | 83346.9 |

**Réflecteur halogène Hexa 12V fermée**  
**Hexagonal halogen reflector lamp 12V, with protective glass**  
**hexagonaal halogeen-reflektorlamp 12V, met frontglas**  
**Riflettore alogeno Hexagonal 12V, con vetro di protezione**  
**Hexagonal Halogen-Reflektorlampe 12V, mit Schutzglas**

6  
**HEXAGONAL**

**GU5,3** **ø51x45mm** **1.500h**

*argent, silver, zilver, argentato, silber*

|     |      |           |   |    |        |         |
|-----|------|-----------|---|----|--------|---------|
| 20W | 45mm | flood 60° | ✓ | 10 | 833.47 | 83347.6 |
| 35W | 45mm | flood 60° | ✓ | 10 | 833.48 | 83348.3 |

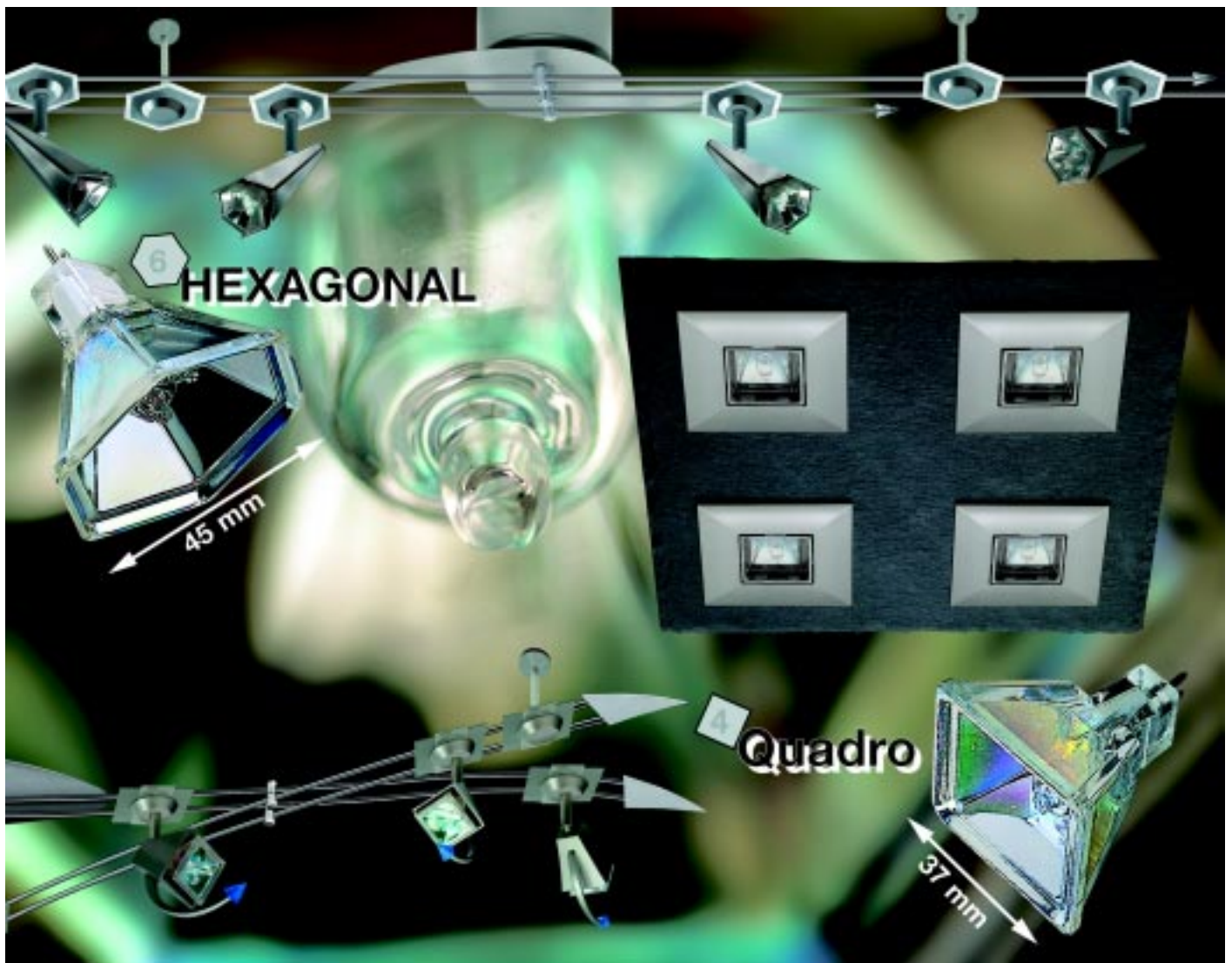



**Lampe Akzent halogène à réflecteur métallisé 12V fermée**  
**Akzent halogen reflector lamp, with front glass**  
**haloogen akzentlampen 12V, met frontglas**  
**Riflettore alogeno Akzent 12V, con vetro di protezione**  
**Akzent-Halogen-Reflektorlampe 12V, mit Schutzglas**

Akzent



**GU5,3 ø51mm (MR16) 4.000h**

*blanc, white, wit, bianco, weiß*

|     |      |               |   |    |        |         |
|-----|------|---------------|---|----|--------|---------|
| 20W | 45mm | BAB flood 38° | ✓ | 10 | 832.26 | 83226.4 |
| 35W | 45mm | FMW flood 38° | ✓ | 10 | 832.36 | 83236.3 |
| 50W | 45mm | EXN flood 38° | ✓ | 10 | 832.56 | 83256.1 |



**GU5,3 ø51mm (MR16) 4.000h**

*noir, black, zwart, nero, schwarz*

|     |      |               |   |    |        |         |
|-----|------|---------------|---|----|--------|---------|
| 20W | 45mm | BAB flood 38° | ✓ | 10 | 832.24 | 83224.0 |
| 35W | 45mm | FMW flood 38° | ✓ | 10 | 832.34 | 83234.9 |
| 50W | 45mm | EXN flood 38° | ✓ | 10 | 832.54 | 83254.7 |



**GU5,3 ø51mm (MR16) 4.000h**

*doré, gold, goud, dorato, gold*

|     |      |               |   |    |        |         |
|-----|------|---------------|---|----|--------|---------|
| 20W | 45mm | BAB flood 38° | ✓ | 10 | 832.27 | 83227.1 |
| 35W | 45mm | FMW flood 38° | ✓ | 10 | 832.37 | 83237.0 |
| 50W | 45mm | EXN flood 38° | ✓ | 10 | 832.57 | 83257.8 |



**GU5,3 ø51mm (MR16) 4.000h**

*argent, silver, zilver, argentato, silber*

|     |      |               |   |    |        |         |
|-----|------|---------------|---|----|--------|---------|
| 20W | 45mm | BAB flood 38° | ✓ | 10 | 832.29 | 83229.5 |
| 35W | 45mm | FMW flood 38° | ✓ | 10 | 832.39 | 83239.4 |
| 50W | 45mm | EXN flood 38° | ✓ | 10 | 832.59 | 83259.2 |



**GU5,3 ø51mm (MR16) 4.000h**

*alu brossé, alu matt, alu mat, color alluminio opaco, alu matt*

|     |      |               |   |    |        |         |
|-----|------|---------------|---|----|--------|---------|
| 20W | 45mm | BAB flood 38° | ✓ | 10 | 832.28 | 83228.8 |
| 35W | 45mm | FMW flood 38° | ✓ | 10 | 832.38 | 83238.7 |
| 50W | 45mm | EXN flood 38° | ✓ | 10 | 832.58 | 83258.5 |



Akzent





**Lampe réflecteur Déco-Akzent 12V fermée**  
**Deko-Akzent reflector lamps 12V with front glass**  
**Deko-Akzent-reflektorlamp 12V, met frontglas**  
**Riflettore alogeno Deko-Akzent 12V, con vetro di protezione**  
**Deko-Akzent-Reflektorlampe 12V, mit Schutzglas**

DECO Akzent

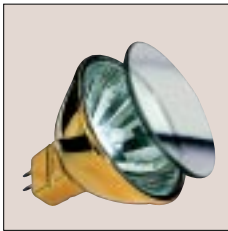

**GU5,3 ø51mm (MR16) 4.000h**

*doré total, full gold, goud, totalmente dorato, vollgold*

|     |      |         |   |    |        |         |
|-----|------|---------|---|----|--------|---------|
| 20W | 45mm | BAB 38° | ✓ | 10 | 832.72 | 83272.1 |
| 35W | 45mm | FMW 38° | ✓ | 10 | 832.73 | 83273.8 |
| 50W | 45mm | EXN 38° | ✓ | 10 | 832.75 | 83275.2 |

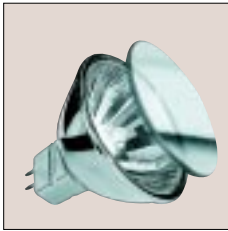

**GU5,3 ø51mm (MR16) 4.000h**

*chrome total, full chrome, chrom, totalmente cromato, vollchrom*

|     |      |         |   |    |        |         |
|-----|------|---------|---|----|--------|---------|
| 20W | 45mm | BAB 38° | ✓ | 10 | 832.62 | 83262.2 |
| 35W | 45mm | FMW 38° | ✓ | 10 | 832.63 | 83263.9 |
| 50W | 45mm | EXN 38° | ✓ | 10 | 832.65 | 83265.3 |



**Halogène-Maxiflood a réflecteur 12V, fermée**  
**Halogen Maxiflood reflector lamp 12V, with front glass**  
**haloegen Maxiflood reflectorlamp 12V, met front**  
**Riflettore alogeno Maxiflood 12V, con vetro di protezione**  
**Halogen-Maxiflood-Reflektorlampe 12V, mit Schutzglas**

MAXI FLOOD



**GU5,3 ø51mm (MR16) 2.000h**

*soft-opale, soft opal, softopaal, opale tenue, softopal*

|     |      |                |   |    |        |         |
|-----|------|----------------|---|----|--------|---------|
| 20W | 45mm | maxiflood 100° | ✓ | 10 | 832.92 | 83292.9 |
| 35W | 45mm | maxiflood 100° | ✓ | 10 | 832.93 | 83293.6 |
| 50W | 45mm | maxiflood 100° | ✓ | 10 | 832.95 | 83295.0 |

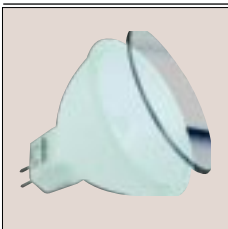

**GU5,3 ø51mm (MR16) 4.000h**

*soft-opale, soft opal, softopaal, opale tenue, softopal*

|     |      |                |   |    |        |         |
|-----|------|----------------|---|----|--------|---------|
| 20W | 45mm | maxiflood 100° | ✓ | 10 | 832.22 | 83222.6 |
| 35W | 45mm | maxiflood 100° | ✓ | 10 | 832.32 | 83232.5 |
| 50W | 45mm | maxiflood 100° | ✓ | 10 | 832.52 | 83252.3 |





Déco-cylindre halogène 12V  
Halogen Dekozylinder 12V  
Halogen-Dekozylinder 12V  
Cilindro alogeno Deko 12V  
Halogen-Dekozylinder 12V

# SECURITY



**GU5,3 ø51mm (MR16) 2.000h**

*clair transparent, clear transparent, helder transparant, chiaro trasparente, klar transparent*

|     |      |               |   |   |        |         |
|-----|------|---------------|---|---|--------|---------|
| 20W | 75mm | BAB flood 38° | ✓ | 6 | 988.24 | 98824.4 |
| 50W | 75mm | EXN flood 38° | ✓ | 6 | 988.54 | 98854.1 |



**GU5,3 ø51mm (MR16) 2.000h**

*satin, satin, satijn, satinato, satin*

|     |      |               |   |   |        |         |
|-----|------|---------------|---|---|--------|---------|
| 20W | 75mm | BAB flood 38° | ✓ | 6 | 988.26 | 98826.8 |
| 35W | 75mm | FMW flood 38° | ✓ | 6 | 988.36 | 98836.7 |
| 50W | 75mm | EXN flood 38° | ✓ | 6 | 988.56 | 98856.5 |

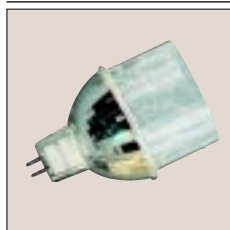

**GU5,3 ø51mm (MR16) 2.000h**

*givré clair, clear kroko-ice, craquelé helder, kraklè chiaro, Krokoeis klar*

|     |      |               |   |   |        |         |
|-----|------|---------------|---|---|--------|---------|
| 20W | 75mm | BAB flood 38° | ✓ | 6 | 988.22 | 98822.0 |
| 50W | 75mm | EXN flood 38° | ✓ | 6 | 988.52 | 98852.7 |

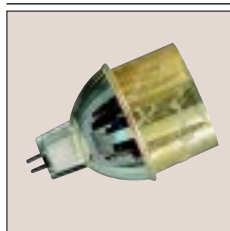

**GU5,3 ø51mm (MR16) 2.000h**

*givré doré, gold kroko-ice, craquelé goud, kraklè dorato, Krokoeis gold*

|     |      |               |   |   |        |         |
|-----|------|---------------|---|---|--------|---------|
| 20W | 75mm | BAB flood 38° | ✓ | 6 | 988.21 | 98821.3 |
| 50W | 75mm | EXN flood 38° | ✓ | 6 | 988.51 | 98851.0 |

**20%**

**80%**

Wärmeverteilung  
Répartition de la chaleur  
Warmteverdeling  
Heat distribution  
Distribución térmica

**SECURITY**

The advertisement features a collage of halogen bulbs in various finishes (clear, satin, cracked, gold) and a modern light fixture with three cylindrical shades. A central graphic highlights the 'SECURITY' technology, which provides 20% more light and 80% more heat distribution compared to standard bulbs. The background shows a bright, modern interior space.



Déco-cylindre halogène 12V  
Halogen Dekozyylinder 12V  
Halogen-Dekozyylinder 12V  
Cilindro alogeno Deko 12V  
Halogen-Dekozyylinder 12V

# SECURITY

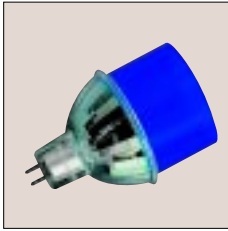

**GU5,3 ø51mm (MR16) 2.000h**

*bleu cobalt, cobalt blue, kobalt-blauw, cobalto-blu, kobaltblau*

|     |      |               |   |   |        |         |
|-----|------|---------------|---|---|--------|---------|
| 20W | 75mm | BAB flood 38° | ✓ | 6 | 988.05 | 98805.3 |
| 35W | 75mm | FMW flood 38° | ✓ | 6 | 988.06 | 98806.0 |
| 50W | 75mm | EXN flood 38° | ✓ | 6 | 988.07 | 98807.7 |

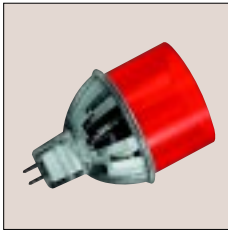

**GU5,3 ø51mm (MR16) 2.000h**

*rouge, red, rood, rosso, rot*

|     |      |               |   |   |        |         |
|-----|------|---------------|---|---|--------|---------|
| 20W | 75mm | BAB flood 38° | ✓ | 6 | 988.00 | 98800.8 |
| 35W | 75mm | FMW flood 38° | ✓ | 6 | 988.01 | 98801.5 |

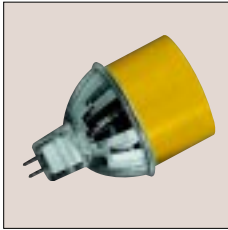

**GU5,3 ø51mm (MR16) 2.000h**

*jaune, yellow, geel, giallo, gelb*

|     |      |               |   |   |        |         |
|-----|------|---------------|---|---|--------|---------|
| 20W | 75mm | BAB flood 38° | ✓ | 6 | 988.02 | 98802.2 |
| 35W | 75mm | FMW flood 38° | ✓ | 6 | 988.03 | 98803.9 |

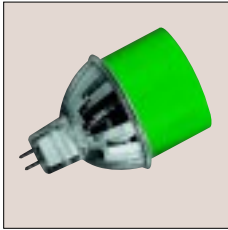

**GU5,3 ø51mm (MR16) 2.000h**

*vert, green, groen, verde, grün*

|     |      |               |   |   |        |         |
|-----|------|---------------|---|---|--------|---------|
| 20W | 75mm | BAB flood 38° | ✓ | 6 | 988.08 | 98808.4 |
| 35W | 75mm | FMW flood 38° | ✓ | 6 | 988.09 | 98809.1 |





Dichroïque Happy Color, 12V, avec verre de protection  
 Happy Color 12V Halogen Dichroic Lamp, with Front-glass  
 Happy Color halogeen-koudlichtspiegel 12V, met frontglas  
 Dicroica Happy Color 12V, con vetro di protezione  
 Happy Color Halogen-Kaltlichtspiegel 12V, mit Schutzglas

Happy Color



**GU5,3 ø51mm (MR16) 4.000h**

*blanc-argent, white-silver, zilver-wit, bianco-argentato, weiß-silber*

|     |      |               |   |    |          |         |
|-----|------|---------------|---|----|----------|---------|
| 20W | 45mm | BAB flood 38° | ✓ | 10 | 8833.269 | 00595.8 |
| 35W | 45mm | FMW flood 38° | ✓ | 10 | 883.3369 | 00605.4 |



**GU5,3 ø51mm (MR16) 4.000h**

*rouge-argent, red-silver, rood-zilver, rosso-argentato, rot-silber*

|     |      |               |   |    |          |         |
|-----|------|---------------|---|----|----------|---------|
| 20W | 45mm | BAB flood 38° | ✓ | 10 | 8833.219 | 00591.0 |
| 35W | 45mm | FMW flood 38° | ✓ | 10 | 883.3319 | 00596.5 |



**GU5,3 ø51mm (MR16) 4.000h**

*jaune-argent, yellow-silver, geel-zilver, giallo-argentato, gelb-silber*

|     |      |               |   |    |          |         |
|-----|------|---------------|---|----|----------|---------|
| 20W | 45mm | BAB flood 38° | ✓ | 10 | 8833.229 | 00592.7 |
| 35W | 45mm | FMW flood 38° | ✓ | 10 | 883.3329 | 00597.2 |



**GU5,3 ø51mm (MR16) 4.000h**

*vert-argent, green-silver, groen-zilver, verde-argentato, grün-silber*

|     |      |               |   |    |          |         |
|-----|------|---------------|---|----|----------|---------|
| 20W | 45mm | BAB flood 38° | ✓ | 10 | 8833.239 | 00593.4 |
| 35W | 45mm | FMW flood 38° | ✓ | 10 | 883.3339 | 00603.0 |



**GU5,3 ø51mm (MR16) 4.000h**

*bleu-argent, blue-silver, blauw-zilver, blu-argentato, blau-silber*

|     |      |               |   |    |          |         |
|-----|------|---------------|---|----|----------|---------|
| 20W | 45mm | BAB flood 38° | ✓ | 10 | 8833.249 | 00594.1 |
| 35W | 45mm | FMW flood 38° | ✓ | 10 | 8833.349 | 00983.3 |





Dichroïque True Color 12V, avec verre de protection  
 12V True Colour Halogen Dichroic Lamp with Front-Glass  
 True Colour halogeen koudlichtspiegel 12V, mit frontglas  
 Dicroica True Colour 12V, con vetro di protezione  
 True Colour Halogen-Kaltlichtspiegel 12V, mit Schutzglas



**GU5,3** **ø51mm (MR16)** **2.000h**

*rouge, red, rood, rosso, rot*

35W 45mm FMW 38° ✓ 10 833.41 83341.4

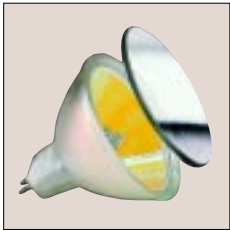

**GU5,3** **ø51mm (MR16)** **2.000h**

*jaune, yellow, geel, giallo, gelb*

35W 45mm FMW 38° ✓ 10 833.42 83342.1

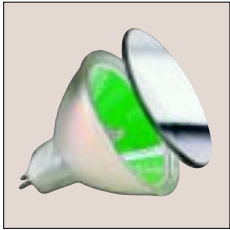

**GU5,3** **ø51mm (MR16)** **2.000h**

*vert, green, groen, verde, grün*

35W 45mm FMW 38° ✓ 10 833.43 83343.8

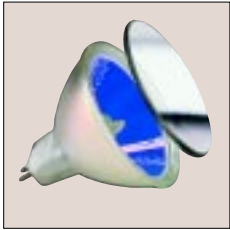

**GU5,3** **ø51mm (MR16)** **2.000h**

*bleu, blue, blauw, blu, blau*

35W 45mm FMW 38° ✓ 10 833.44 83344.5





Miroir alu, 12V  
 Alu mirror, 12V  
 Aluspiegel, 12V  
 Lampada specchio in alluminio, 12V  
 Halogen-Aluspiegel, 12V

**G4****ø48mm****2.000h**

argent, silver, zilver, argentato, silber

20W

36mm

8°



10

830.299

00434.0

H1, 12V, pour Tizio  
 H1, 12V, for Tizio  
 H1, 12V, voor Tizio  
 H1, 12V, per Tizio  
 Halogen-H1, 12V, für Tizio

**P14,5s****1.500h**

clair, clear, helder, chiaro, klar

55W

60mm

4

832.55

83255.4

halogène QR 111 12V  
 QR 111 Halogen Lamp 12V  
 QR111 halogenlamp 12V  
 Lampadina alogena QR 111 12V  
 QR 111 Halogenlampe 12V



New

**G53****ø111mm****2.000h**

argent, silver, zilver, argentato, silber

50W

54mm

24°



1

830.209

00435.7





**Barette halogène 230V**  
**230V Double-base Halogen Lamp**  
**Staafhalogeen 230V**  
**Lampadina alogena lineare 230V**  
**Halogenstab 230V**

230V

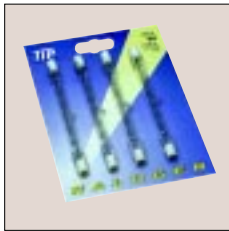

**R7s** **ø10mm**  
*clair, clear, helder, chiaro, klar*

**1.000h**

**TIP**

|        |       |   |    |               |         |
|--------|-------|---|----|---------------|---------|
| 4x300W | 117mm | ✓ | 10 | <b>845.34</b> | 84534.9 |
| 4x500W | 117mm | ✓ | 10 | <b>845.54</b> | 84554.7 |



**R7s** **ø10mm**  
*clair, clear, helder, chiaro, klar*

**1.000h**

**TIP**

|      |       |  |    |               |         |
|------|-------|--|----|---------------|---------|
| 200W | 117mm |  | 25 | <b>840.21</b> | 84021.4 |
| 300W | 117mm |  | 25 | <b>840.31</b> | 84031.3 |
| 500W | 117mm |  | 25 | <b>840.51</b> | 84051.1 |



**R7s** **ø10mm**  
*clair, clear, helder, chiaro, klar*

**1.500h**

**ECO**

|      |       |  |    |               |         |
|------|-------|--|----|---------------|---------|
| 100W | 117mm |  | 25 | <b>830.09</b> | 83009.3 |
| 200W | 117mm |  | 25 | <b>830.21</b> | 83021.5 |
| 300W | 117mm |  | 25 | <b>830.31</b> | 83031.4 |
| 500W | 117mm |  | 25 | <b>830.51</b> | 83051.2 |



**R7s** **ø12mm**  
*clair, clear, helder, chiaro, klar*

**2.000h**

|      |       |   |    |                |         |
|------|-------|---|----|----------------|---------|
| 100W | 117mm |   | 12 | <b>834.06</b>  | 83406.0 |
| 100W | 117mm | ✓ | 10 | <b>834.09</b>  | 83409.1 |
| 150W | 117mm |   | 12 | <b>834.16</b>  | 83416.9 |
| 150W | 117mm | ✓ | 10 | <b>834.18</b>  | 83418.3 |
| 200W | 117mm |   | 12 | <b>834.20</b>  | 83420.6 |
| 200W | 117mm | ✓ | 10 | <b>834.209</b> | 00447.0 |
| 250W | 117mm |   | 12 | <b>834.25</b>  | 83425.1 |
| 300W | 117mm |   | 12 | <b>834.30</b>  | 83430.5 |
| 300W | 117mm | ✓ | 10 | <b>834.309</b> | 00449.4 |
| 500W | 117mm |   | 12 | <b>834.50</b>  | 83450.3 |
| 500W | 117mm | ✓ | 10 | <b>834.509</b> | 00450.0 |



**R7s** **ø12mm**  
*clair, clear, helder, chiaro, klar*

**2.000h**

|       |       |  |    |               |         |
|-------|-------|--|----|---------------|---------|
| 1000W | 189mm |  | 12 | <b>834.10</b> | 83410.7 |
|-------|-------|--|----|---------------|---------|

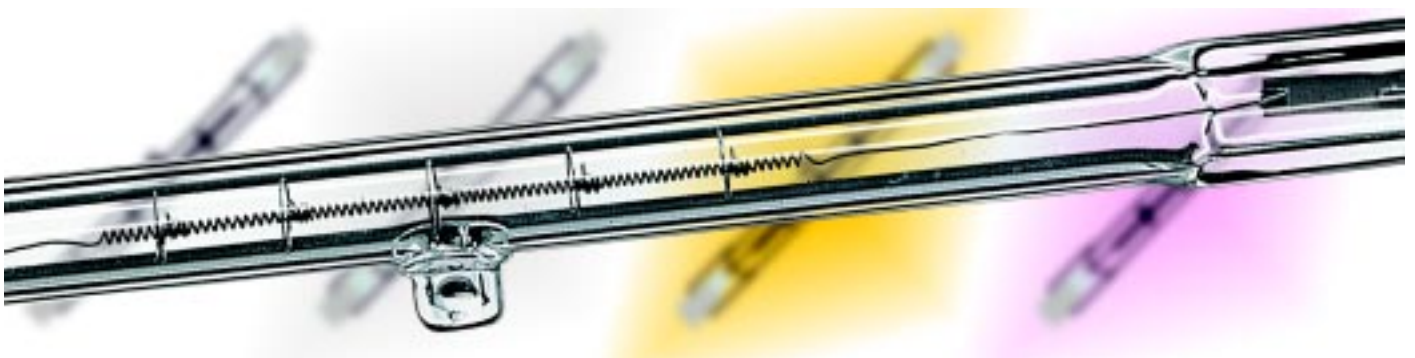



**Barrette halogène 2000H**  
**Double-based halogen lamps 2000, 230V**  
**tweekneepslamp 2000**  
**Lampadina alogena lineare 2000, 230V**  
**Halogenstab 2000, 230V**

230V

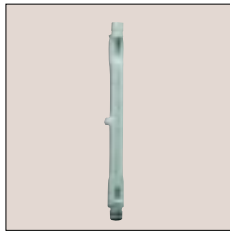
**R7s****ø12mm****2.000h***satin, satin, satijn, satinato, satin*

300W

117mm



10

**834.302**

83432.9

**R7s****ø12mm****2.000h***rosé, rosé, roze, rosato, rosé*

300W

117mm



10

**834.3019**

00486.9

**R7s****ø12mm****2.000h***doré, gold, goud, dorato, gold*

100W

117mm



10

**834.07**

83407.7

200W

117mm



10

**834.27**

83427.5

300W

117mm



10

**834.3079**

00482.1

500W

117mm



10

**834.5079**

00754.9

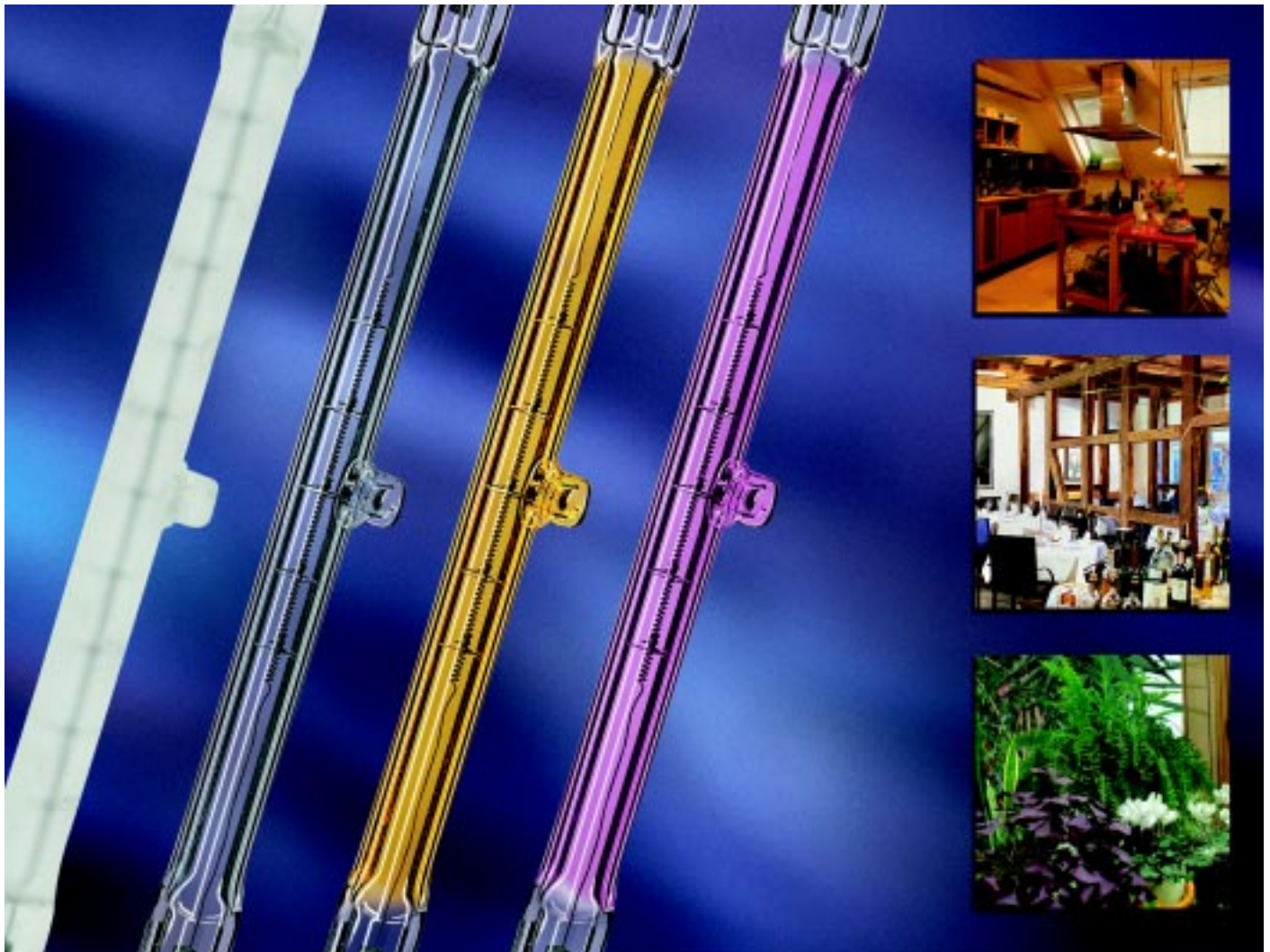



**Barette halogène 230V**  
**230V Double-base Halogen Lamp**  
**Staafhalogeen 230V**  
**Lampadina alogena lineare 230V**  
**Halogenstab 230V**

230V



**R7s** **ø10mm**  
*clair, clear, helder, chiaro, klar*

**1.000h**

**TIP**

|        |      |   |    |               |         |
|--------|------|---|----|---------------|---------|
| 4x100W | 78mm | ✓ | 10 | <b>844.14</b> | 84414.4 |
| 4x150W | 78mm | ✓ | 10 | <b>844.24</b> | 84424.3 |



**R7s** **ø10mm**  
*clair, clear, helder, chiaro, klar*

**1.000h**

**TIP**

|      |      |  |    |               |         |
|------|------|--|----|---------------|---------|
| 100W | 78mm |  | 25 | <b>840.11</b> | 84011.5 |
| 150W | 78mm |  | 25 | <b>840.16</b> | 84016.0 |



**R7s** **ø10mm**  
*clair, clear, helder, chiaro, klar*

**1.500h**

**ECO**

|      |      |  |    |               |         |
|------|------|--|----|---------------|---------|
| 100W | 78mm |  | 25 | <b>830.11</b> | 83011.6 |
| 150W | 78mm |  | 25 | <b>830.16</b> | 83016.1 |



**R7s** **ø12mm**  
*clair, clear, helder, chiaro, klar*

**2.000h**

|      |      |   |    |                 |         |
|------|------|---|----|-----------------|---------|
| 60W  | 78mm |   | 12 | <b>834.60</b>   | 83460.2 |
| 60W  | 78mm | ✓ | 10 | <b>834.61</b>   | 83461.9 |
| 75W  | 78mm |   | 12 | <b>834.70</b>   | 83470.1 |
| 100W | 78mm |   | 12 | <b>834.010</b>  | 83401.5 |
| 100W | 78mm | ✓ | 10 | <b>834.19</b>   | 83419.0 |
| 150W | 78mm |   | 12 | <b>834.015</b>  | 83405.3 |
| 150W | 78mm | ✓ | 10 | <b>834.0159</b> | 00444.9 |
| 200W | 78mm |   | 12 | <b>834.020</b>  | 83402.2 |
| 250W | 78mm | ✓ | 10 | <b>834.05</b>   | 83499.2 |

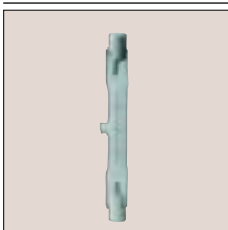

**R7s** **ø12mm**  
*satin, satin, satijn, satinato, satin*

**2.000h**

|      |      |   |    |                |         |
|------|------|---|----|----------------|---------|
| 150W | 78mm | ✓ | 10 | <b>834.052</b> | 83454.1 |
|------|------|---|----|----------------|---------|

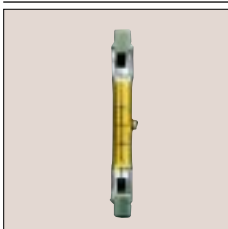

**R7s** **ø12mm**  
*doré, gold, goud, dorato, gold*

**2.000h**

|      |      |   |    |                |         |
|------|------|---|----|----------------|---------|
| 100W | 78mm | ✓ | 10 | <b>834.17</b>  | 83417.6 |
| 150W | 78mm | ✓ | 10 | <b>834.057</b> | 83458.9 |





**TIP Bi-pin halogène 230V**  
**230V TIP Halogen Capsule**  
**TIP 230V Halogeen steeklampje**  
**Lampadina alogena bispina TIP 230V**  
**TIP 230V-Halogen-Stiftsockel**

TIP 230V

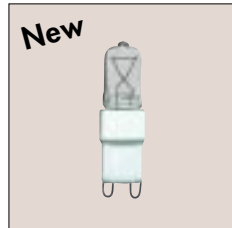

**G9** **ø17,5mm** **1.500h**  
*clair, clear, helder, chiaro, klar*

|     |      |    |        |         |
|-----|------|----|--------|---------|
| 25W | 56mm | 10 | 831.71 | 83171.7 |
| 40W | 56mm | 10 | 831.72 | 83172.4 |
| 60W | 60mm | 10 | 831.73 | 83173.1 |
| 75W | 60mm | 10 | 831.74 | 83174.8 |



**G9** **ø17,5mm** **1.500h**  
*satin, satin, satijn, satinato, satin*

|     |      |    |        |         |
|-----|------|----|--------|---------|
| 25W | 56mm | 10 | 831.75 | 83175.5 |
| 40W | 56mm | 10 | 831.76 | 83176.2 |
| 60W | 60mm | 10 | 831.77 | 83177.9 |
| 75W | 60mm | 10 | 831.78 | 83178.6 |

**Bi-pin halogène 230V**  
**230V Halogen Capsule**  
**Halogeen steeklampje 230V**  
**Lampadina alogena bispina 230V**  
**230V Halogen-Stiftsockel**

230V



**G9** **ø13mm** **2.000h**  
*clair, clear, helder, chiaro, klar*

|     |      |    |        |         |
|-----|------|----|--------|---------|
| 40W | 44mm | 10 | 831.94 | 83194.6 |
| 60W | 44mm | 10 | 831.95 | 83195.3 |

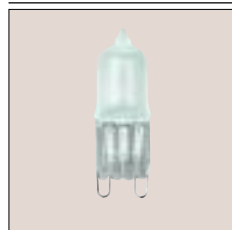

**G9** **ø14mm** **2.000h**  
*satin, satin, satijn, satinato, satin*

|     |      |    |        |         |
|-----|------|----|--------|---------|
| 25W | 54mm | 10 | 831.90 | 83190.8 |
| 40W | 44mm | 10 | 831.91 | 83191.5 |
| 60W | 44mm | 10 | 831.92 | 83192.2 |
| 75W | 54mm | 10 | 831.93 | 83193.9 |





**230V DecoPipe halogène, forme droite**  
**Halogen DecoPipe 230V, straight form**  
**halogeen DecoPipe 230V, recht model**  
**DecoPipe alogeno 230V, forma diritta**  
**Halogen DecoPipe 230V, gerade Form**

230V



New

**G9****ø23mm****1.500h***satín, satin, satijn, satinato, satin*

|     |      |    |               |         |
|-----|------|----|---------------|---------|
| 40W | 90mm | 10 | <b>831.96</b> | 83196.0 |
| 60W | 90mm | 10 | <b>831.97</b> | 83197.7 |

**230V DecoPipe halogène, forme en biais**  
**Halogen DecoPipe 230V, curved form**  
**halogeen DecoPipe 230V, schuin model**  
**230V DecoPipe alogeno, forma obliqua**  
**Halogen DecoPipe 230V, schräge Form**

230V



New

**G9****ø23mm****1.500h***satín, satin, satijn, satinato, satin*

|     |      |    |               |         |
|-----|------|----|---------------|---------|
| 40W | 90mm | 10 | <b>831.98</b> | 83198.4 |
| 60W | 90mm | 10 | <b>831.99</b> | 83199.1 |

**DecoMini halogène 230V**  
**Halogen DecoMini 230V**  
**halogeen DecoMini 230V**  
**DecoMini alogeno 230V**  
**Halogen DecoMini 230V**

230V



New

**G9****ø23mm****1.500h***satín, satin, satijn, satinato, satin*

|     |      |    |               |         |
|-----|------|----|---------------|---------|
| 40W | 79mm | 10 | <b>831.88</b> | 83188.5 |
| 60W | 79mm | 10 | <b>831.89</b> | 83189.2 |



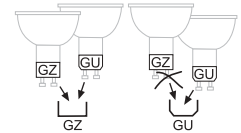

**230V DecoPipe halogène, forme droite**  
**Halogen DecoPipe 230V, straight form**  
**halogeen DecoPipe 230V, recht model**  
**DecoPipe alogeno 230V, forma diritta**  
**Halogen DecoPipe 230V, gerade Form**

**GZ10** **ø23mm****1.500h***satin, satin, satijn, satinato, satin*

|     |      |    |               |                |
|-----|------|----|---------------|----------------|
| 35W | 80mm | 10 | <b>836.15</b> | <b>83615.6</b> |
| 50W | 80mm | 10 | <b>836.16</b> | <b>83616.3</b> |

**230V DecoPipe halogène, forme en biais**  
**Halogen DecoPipe 230V, curved form**  
**halogeen DecoPipe 230V, schuin model**  
**230V DecoPipe alogeno, forma obliqua**  
**Halogen DecoPipe 230V, schräge Form**

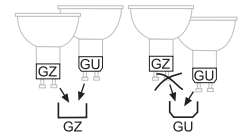
**GZ10** **ø23mm****1.500h***satin, satin, satijn, satinato, satin*

|     |      |    |               |                |
|-----|------|----|---------------|----------------|
| 35W | 80mm | 10 | <b>836.17</b> | <b>83617.0</b> |
| 50W | 80mm | 10 | <b>836.18</b> | <b>83618.7</b> |

**DecoMini halogène 230V**  
**Halogen DecoMini 230V**  
**halogeen DecoMini 230V**  
**DecoMini alogeno 230V**  
**Halogen DecoMini 230V**

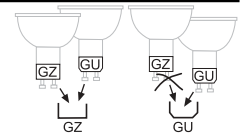
**GZ10** **ø28mm****1.500h***clair, clear, helder, chiaro, klar*

|     |      |   |    |               |                |
|-----|------|---|----|---------------|----------------|
| 35W | 62mm | ✓ | 10 | <b>836.11</b> | <b>83611.8</b> |
| 50W | 62mm | ✓ | 10 | <b>836.13</b> | <b>83613.2</b> |

**GZ10** **ø28mm****1.500h***satin, satin, satijn, satinato, satin*

|     |      |   |    |               |                |
|-----|------|---|----|---------------|----------------|
| 35W | 62mm | ✓ | 10 | <b>836.12</b> | <b>83612.5</b> |
| 50W | 62mm | ✓ | 10 | <b>836.14</b> | <b>83614.9</b> |





**Réflecteur halogène TIP 230V**  
**230V TIP Halogen Reflector Lamp**  
**TIP halogeen reflektorlamp 230V**  
**Riflettore alogeno TIP 230V**  
**TIP Halogen-Reflektorlampe 230V**

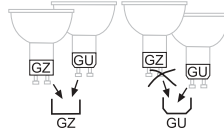

New

**GZ10****ø51mm****1.500h***chrome, chrome, chroom, cromo, chrom*

|     |      |     |    |               |         |
|-----|------|-----|----|---------------|---------|
| 35W | 52mm | 35° | 10 | <b>836.37</b> | 83637.8 |
| 50W | 52mm | 35° | 10 | <b>836.57</b> | 83657.6 |

**Réflecteur Joyau TIP 230V**  
**TIP Juwel Halogen Reflector Lamp 230V**  
**Tip juwel halogeen reflektorlamp 230V**  
**Riflettore alogeno TIP Juwel 230V**  
**TIP Juwel-Halogen-Reflektorlampe 230V**

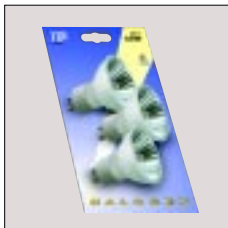
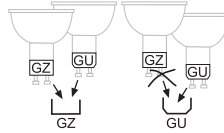
**GZ10****ø51mm****1.500h***satin, satin, satijn, satinato, satin*

|       |      |           |   |    |             |         |
|-------|------|-----------|---|----|-------------|---------|
| 3x50W | 52mm | flood 35° | ✓ | 10 | <b>3223</b> | 03223.7 |
|-------|------|-----------|---|----|-------------|---------|

**réflecteur Maxiflood GZ10**  
**High-voltage Maxiflood Reflector Lamp GZ10**  
**Hoogvolt-maxiflood-reflektorlamp GZ10**  
**Riflettore Maxiflood ad alto voltaggio GZ10**  
**Hochvolt-Maxiflood-Reflektorlampe GZ10**

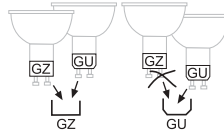
**MAXI FLOOD**

New

**GZ10****ø51mm****1.500h***soft-opale, soft opal, softopaal, opale tenue, softopal*

|     |      |                |    |               |         |
|-----|------|----------------|----|---------------|---------|
| 35W | 52mm | maxiflood 100° | 10 | <b>836.09</b> | 83609.5 |
| 50W | 52mm | maxiflood 100° | 10 | <b>836.10</b> | 83610.1 |





**Réflecteur Joyau TIP 230V**  
**TIP Juwel Halogen Reflector Lamp 230V**  
**Tip juwel halogeen reflektorlamp 230V**  
**Riflettore alogeno TIP Juwel 230V**  
**TIP Juwel-Halogen-Reflektorlampe 230V**

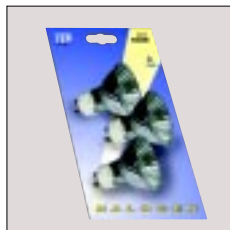

**GU10** **ø51mm** **1.500h**

*argent, silver, zilver, argentato, silber*

|       |      |           |   |    |      |         |
|-------|------|-----------|---|----|------|---------|
| 3x50W | 52mm | flood 35° | ✓ | 10 | 3224 | 03224.4 |
| 3x35W | 52mm | flood 35° | ✓ | 10 | 3230 | 03230.5 |

**Réflecteur halogène TIP 230V**  
**230V TIP Halogen Reflector Lamp**  
**TIP halogeen reflektorlamp 230V**  
**Riflettore alogeno TIP 230V**  
**TIP Halogen-Reflektorlampe 230V**



**GU10** **ø51mm** **1.500h**

*chrome, chrome, chroom, cromo, chrom*

|     |      |     |  |    |        |         |
|-----|------|-----|--|----|--------|---------|
| 35W | 52mm | 35° |  | 10 | 836.36 | 83636.1 |
| 50W | 52mm | 35° |  | 10 | 836.56 | 83656.9 |

**Réflecteur halogène**  
**Halogen reflector lamp**  
**Halogeen reflektorlamp**  
**Riflettore alogeno**  
**Halogen-Reflektorlampe**



**GU10** **ø51mm** **2.000h**

*chrome, chrome, chroom, cromo, chrom*

|     |      |                 |   |    |        |         |
|-----|------|-----------------|---|----|--------|---------|
| 50W | 52mm | Alurefektor 35° | ✓ | 10 | 836.50 | 83650.7 |
|-----|------|-----------------|---|----|--------|---------|

**Xenoncolor daylight, réflecteur halogène 230V**  
**Xenoncolor daylight, halogen reflector lamp 230V**  
**Xenoncolor daglicht, halogeen reflektorlamp 230V**  
**Xenoncolor daylight, riflettore alogeno 230V**  
**Xenoncolor daylight, Halogen-Reflektorlampe 230V**



New

**GU10** **ø51mm** **1.500h**

*chrome, chrome, chroom, cromo, chrom*

|     |      |          |   |    |        |         |
|-----|------|----------|---|----|--------|---------|
| 35W | 52mm | GU10 35° | ✓ | 10 | 836.07 | 83607.1 |
| 50W | 52mm | GU10 35° | ✓ | 10 | 836.08 | 83608.8 |



**XENON**  
**COLOR**  
 4200° K

**HALOGEN**  
**230 V**



**réflecteur halogène Akzent 230V**  
**230V Akzent Halogen Reflector Lamp**  
**Akzent halogeen reflectorlamp 230V**  
**Riflettore alogeno Akzent 230V**  
**Akzent-Halogen-Reflektorlampe 230V**



**GU10** **ø51mm** **1.500h**

*noir, black, zwart, nero, schwarz*

|     |      |     |   |    |        |         |
|-----|------|-----|---|----|--------|---------|
| 35W | 52mm | 38° | ✓ | 10 | 836.02 | 83602.6 |
|-----|------|-----|---|----|--------|---------|



**GU10** **ø51mm** **1.500h**

*alu brossé, alu matt, alu mat, color alluminio opaco, alu matt*

|     |      |     |   |    |        |         |
|-----|------|-----|---|----|--------|---------|
| 35W | 52mm | 38° | ✓ | 10 | 836.01 | 83601.9 |
| 50W | 52mm | 38° | ✓ | 10 | 836.06 | 83606.4 |



**GU10** **ø51mm** **1.500h**

*doré, gold, goud, dorato, gold*

|     |      |     |   |    |        |         |
|-----|------|-----|---|----|--------|---------|
| 35W | 52mm | 38° | ✓ | 10 | 836.03 | 83603.3 |
|-----|------|-----|---|----|--------|---------|



**GU10** **ø51mm** **1.500h**

*satin, satin, satijn, satinato, satin*

|     |      |     |   |    |        |         |
|-----|------|-----|---|----|--------|---------|
| 50W | 52mm | 38° | ✓ | 10 | 836.04 | 83604.0 |
|-----|------|-----|---|----|--------|---------|



**GU10** **ø51mm** **1.500h**

*bleu, blue, blauw, blu, blau*

|     |      |     |   |    |        |         |
|-----|------|-----|---|----|--------|---------|
| 35W | 52mm | 38° | ✓ | 10 | 836.05 | 83605.7 |
|-----|------|-----|---|----|--------|---------|

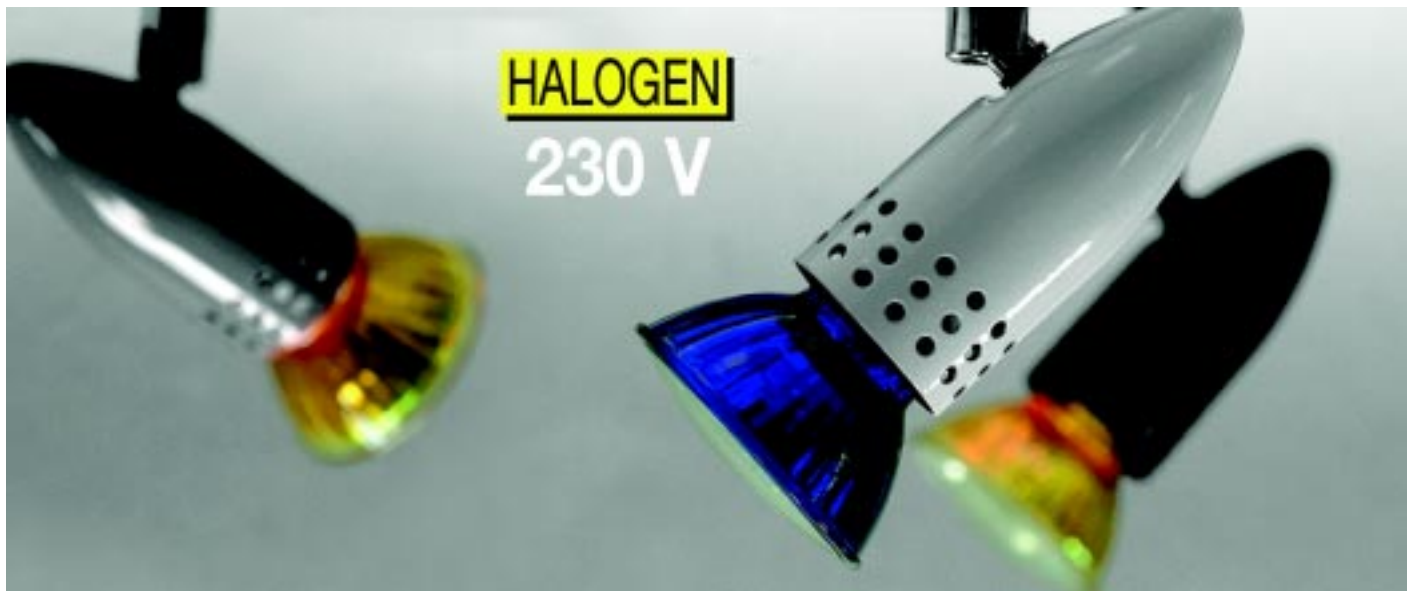



Réflecteur halogène True color 230V  
 True Color 230V Halogen Reflector Lamp  
 True color Halogeen Reflektorlamp 230V  
 Riflettore alogeno True color 230V  
 True Colour Halogen Reflektorlampe 230V

TRUECOLOR



**GU10** **ø51mm** **1.500h**  
 rouge, red, rood, rosso, rot  
 50W 52mm True color 35° 10 836.21 83621.7



**GU10** **ø51mm** **1.500h**  
 jaune, yellow, geel, giallo, gelb  
 50W 52mm True color 35° 10 836.22 83622.4



**GU10** **ø51mm** **1.500h**  
 vert, green, groen, verde, grün  
 50W 52mm True color 35° 10 836.23 83623.1



**GU10** **ø51mm** **1.500h**  
 bleu, blue, blauw, blu, blau  
 50W 52mm True color 35° 10 836.20 83620.0





**DecoMini halogène 230V**  
**Halogen DecoMini 230V**  
**halogeen DecoMini 230V**  
**DecoMini alogeno 230V**  
**Halogen DecoMini 230V**

230V

New

**E14****ø23mm****1.500h***satin, satin, satijn, satinato, satin*

|     |      |   |    |        |         |
|-----|------|---|----|--------|---------|
| 40W | 90mm | ✓ | 10 | 835.80 | 83580.7 |
| 60W | 90mm | ✓ | 10 | 835.81 | 83581.4 |

**Ampoule halogène 230V**  
**Halogen lamp 230V**  
**halogeenlampen 230V**  
**Lampadina alogena 230V**  
**Halogenlampe 230V**

230V

**E14****ø20mm****1.500h***clair, clear, helder, chiaro, klar*

|      |      |   |    |        |         |
|------|------|---|----|--------|---------|
| 75W  | 75mm | ✓ | 10 | 837.70 | 83770.2 |
| 100W | 75mm | ✓ | 10 | 837.10 | 83710.8 |
| 150W | 75mm | ✓ | 10 | 837.15 | 83715.3 |
| 250W | 75mm | ✓ | 10 | 837.25 | 83725.2 |

**E14****ø20mm****1.500h***dépoli, matt, mat, opaco, matt*

|      |      |   |    |        |         |
|------|------|---|----|--------|---------|
| 75W  | 75mm | ✓ | 10 | 837.71 | 83771.9 |
| 100W | 75mm | ✓ | 10 | 837.11 | 83711.5 |
| 150W | 75mm | ✓ | 10 | 837.16 | 83716.0 |

**B15d****ø18mm****1.500h***dépoli, matt, mat, opaco, matt*

|      |      |   |    |        |         |
|------|------|---|----|--------|---------|
| 40W  | 80mm | ✓ | 10 | 839.40 | 83940.9 |
| 60W  | 80mm | ✓ | 10 | 839.60 | 83960.7 |
| 75W  | 80mm | ✓ | 10 | 839.70 | 83970.6 |
| 100W | 80mm | ✓ | 10 | 839.00 | 83900.3 |
| 150W | 80mm | ✓ | 10 | 839.15 | 83915.7 |
| 250W | 80mm | ✓ | 10 | 839.25 | 83925.6 |





**Flamme halogène 230V torsadée**  
**Twisted halogen candle lamp 230V**  
**halogeen gedraaide kaarslamp 230V**  
**Lampadina alogena a candela 230V tortiglione**  
**Halogen-Kerzenlampe 230V gedreht**

230V

**E14****ø35mm****1.500h***clair, clear, helder, chiaro, klar*

|     |      |   |    |        |         |
|-----|------|---|----|--------|---------|
| 40W | 97mm | ✓ | 10 | 837.45 | 83745.0 |
| 60W | 97mm | ✓ | 10 | 837.65 | 83765.8 |

**Ampoule halogène BTT 230V**  
**Halogen lamp 230V, with bulb**  
**halogeenlamp, eivormig**  
**Lampadina alogena 230V, con rigonfiamento**  
**Halogenlampe 230V, mit Bauch**

230V

**E27****ø48mm****2.000h***clair, clear, helder, chiaro, klar*

|      |       |   |    |        |         |
|------|-------|---|----|--------|---------|
| 60W  | 117mm | ✓ | 10 | 835.78 | 83578.4 |
| 100W | 117mm | ✓ | 10 | 835.18 | 00677.1 |
| 150W | 117mm | ✓ | 10 | 835.58 | 83558.6 |

**E27****ø48mm****2.000h***opale, opal, opaal, opale, opal*

|      |       |   |    |        |         |
|------|-------|---|----|--------|---------|
| 60W  | 117mm | ✓ | 10 | 835.79 | 83579.1 |
| 100W | 117mm | ✓ | 10 | 835.19 | 83519.7 |
| 150W | 117mm | ✓ | 10 | 835.59 | 83559.3 |

**B22d****ø48mm****2.000h***dépoli, matt, mat, opaco, matt*

|      |       |   |    |        |         |
|------|-------|---|----|--------|---------|
| 100W | 117mm | ✓ | 10 | 835.13 | 83513.5 |
| 150W | 117mm | ✓ | 10 | 835.53 | 83553.1 |

**Ampoule halogène 230V**  
**Halogen lamp 230V**  
**halogeenlampen 230V**  
**Lampadina alogena 230V**  
**Halogenlampe 230V**

230V

**E27****ø31mm****2.000h***clair, clear, helder, chiaro, klar*

|      |       |   |    |        |         |
|------|-------|---|----|--------|---------|
| 60W  | 90mm  | ✓ | 10 | 835.60 | 83560.9 |
| 75W  | 90mm  | ✓ | 10 | 835.70 | 83570.8 |
| 100W | 90mm  | ✓ | 10 | 835.10 | 83510.4 |
| 150W | 105mm | ✓ | 10 | 835.50 | 83550.0 |

**E27****ø31mm****2.000h***dépoli, matt, mat, opaco, matt*

|      |       |   |    |        |         |
|------|-------|---|----|--------|---------|
| 60W  | 90mm  | ✓ | 10 | 835.61 | 83561.6 |
| 75W  | 90mm  | ✓ | 10 | 835.71 | 83571.5 |
| 100W | 90mm  | ✓ | 10 | 835.11 | 83511.1 |
| 150W | 105mm | ✓ | 10 | 835.51 | 83551.7 |
| 250W | 105mm | ✓ | 10 | 835.52 | 83552.4 |



**PAR16 halogène réflecteur aluminium 230V**  
**230V PAR16 Halogen Alu Reflector Lamp**  
**PAR16 Halogen reflectorlamp 230V**  
**Riflettore alogeno in alluminio PAR16 230V**  
**PAR16 Halogen-Alu-Reflektorlampe 230V**

230V HALOGEN

**E14****ø51 mm****1.500h***clair, clear, helder, chiaro, klar*

|     |      |           |   |    |        |         |
|-----|------|-----------|---|----|--------|---------|
| 35W | 75mm | flood 30° | ✓ | 10 | 208.35 | 20835.9 |
| 50W | 75mm | flood 30° | ✓ | 10 | 208.50 | 20850.2 |

**PAR16 réflecteur halogène Akzent 230V**  
**230V PAR16 Akzent Halogen Reflector Lamp**  
**PAR16 Akzent halogen reflectorlamp 230V**  
**Riflettore alogeno Akzent PAR 16 230V**  
**PAR16 Akzent-Halogen-Alu-Reflektorlampe 230V**

230V HALOGEN

**E14****ø51 mm****1.500h***noir, black, zwart, nero, schwarz*

|     |      |           |   |    |        |         |
|-----|------|-----------|---|----|--------|---------|
| 35W | 75mm | flood 30° | ✓ | 10 | 208.02 | 20802.1 |
|-----|------|-----------|---|----|--------|---------|

**E14****ø51 mm****1.500h***alu brossé, alu matt, alu mat, color alluminio opaco, alu matt*

|     |      |           |   |    |        |         |
|-----|------|-----------|---|----|--------|---------|
| 35W | 75mm | flood 30° | ✓ | 10 | 208.01 | 20801.4 |
|-----|------|-----------|---|----|--------|---------|

**E14****ø51 mm****1.500h***doré, gold, goud, dorato, gold*

|     |      |           |   |    |        |         |
|-----|------|-----------|---|----|--------|---------|
| 35W | 75mm | flood 30° | ✓ | 10 | 208.03 | 20803.8 |
|-----|------|-----------|---|----|--------|---------|

**E14****ø51 mm****1.500h***satin, satin, satijn, satinato, satin*

|     |      |           |   |    |        |         |
|-----|------|-----------|---|----|--------|---------|
| 35W | 75mm | flood 30° | ✓ | 10 | 208.04 | 20804.5 |
|-----|------|-----------|---|----|--------|---------|

**E14****ø51 mm****1.500h***bleu, blue, blauw, blu, blau*

|     |      |           |   |    |        |         |
|-----|------|-----------|---|----|--------|---------|
| 35W | 75mm | flood 30° | ✓ | 10 | 208.05 | 20805.2 |
|-----|------|-----------|---|----|--------|---------|





**PAR16 halogène réflecteur aluminium 230V**  
**230V PAR16 Halogen Alu Reflector Lamp**  
**PAR16 Halogeen reflectorlamp 230V**  
**Riflettore alogeno in alluminio PAR16 230V**  
**PAR16 Halogen-Alu-Reflektorlampe 230V**

230V HALOGEN

**E27****ø51mm****1.500h***clair, clear, helder, chiaro, klar*

|     |      |           |   |    |        |         |
|-----|------|-----------|---|----|--------|---------|
| 35W | 75mm | flood 30° | ✓ | 10 | 209.35 | 20935.6 |
| 50W | 75mm | flood 30° | ✓ | 10 | 209.50 | 20950.9 |

**PAR20 halogène réflecteur aluminium 230V**  
**230V PAR20 Halogen Alu Reflector Lamp**  
**PAR20 Halogeen reflectorlamp 230V**  
**Riflettore alogeno in alluminio PAR20 230V**  
**PAR20 Halogen-Alu-Reflektorlampe 230V**

230V HALOGEN

**E27****ø65mm****1.500h***clair, clear, helder, chiaro, klar*

|     |      |           |   |    |        |         |
|-----|------|-----------|---|----|--------|---------|
| 50W | 85mm | flood 30° | ✓ | 10 | 229.50 | 22950.7 |
|-----|------|-----------|---|----|--------|---------|

**PAR30 halogène réflecteur aluminium 230V**  
**230V PAR30 Halogen Alu Reflector Lamp**  
**PAR30 Halogeen reflectorlamp 230V**  
**Riflettore alogeno in alluminio PAR30 230V**  
**PAR30 Halogen-Alu-Reflektorlampe 230V**

230V HALOGEN

**E27****ø95mm****1.500h***clair, clear, helder, chiaro, klar*

|     |      |           |   |    |        |         |
|-----|------|-----------|---|----|--------|---------|
| 50W | 95mm | flood 30° | ✓ | 10 | 249.50 | 24950.5 |
| 75W | 95mm | flood 30° | ✓ | 10 | 249.75 | 24975.8 |

**PAR30 halogène réflecteur aluminium pour plantes 230V**  
**230V PAR30 Halogen Alu Plant Lamp**  
**PAR30 Halogeen plantenlamp 230V**  
**Lampadina alogena in alluminio per piante PAR30 230V**  
**PAR30 Halogen-Alu-Pflanzenlampe 230V**

230V HALOGEN

**E27****ø95mm****1.500h***rosé, rosé, roze, rosato, rosé*

|     |      |           |  |   |        |         |
|-----|------|-----------|--|---|--------|---------|
| 75W | 95mm | flood 30° |  | 4 | 249.71 | 24971.0 |
|-----|------|-----------|--|---|--------|---------|

**PAR38 halogène réflecteur aluminium 230V**  
**230V PAR38 Halogen Alu Reflector Lamp**  
**PAR38 Halogeen reflectorlamp 230V**  
**Riflettore alogeno in alluminio PAR38 230V**  
**PAR38 Halogen-Alu-Reflektorlampe 230V**

230V HALOGEN

**E27****ø122mm****1.500h***clair, clear, helder, chiaro, klar*

|      |       |           |   |    |        |         |
|------|-------|-----------|---|----|--------|---------|
| 75W  | 136mm | flood 30° | ✓ | 10 | 279.75 | 27975.5 |
| 100W | 136mm | flood 30° | ✓ | 10 | 279.00 | 27900.7 |

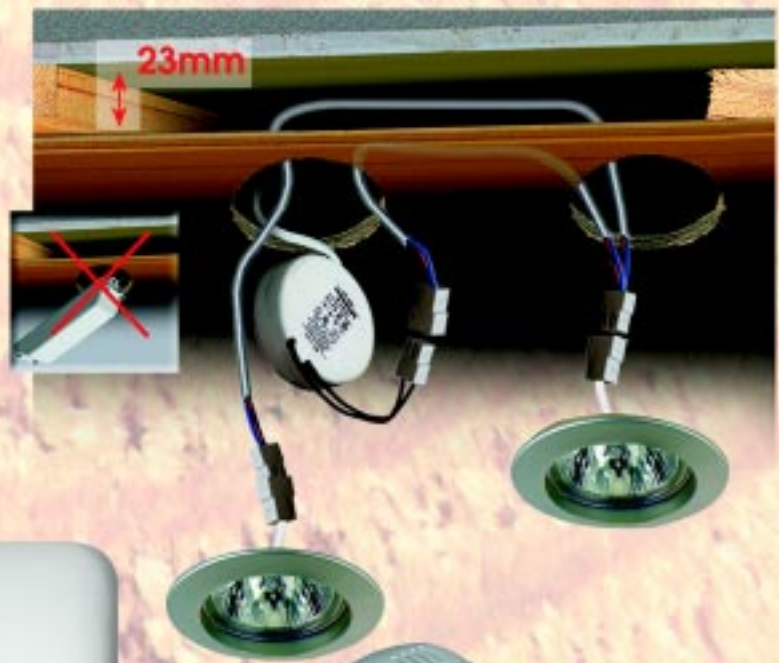

**ECO  
EURO  
DEKO  
DISC  
IP44  
IP65  
MIPRO  
PROFI  
POTI  
SINUS  
TIP  
TOUCH**





transfo avec 3 ans de garantie



Transformer with 3 year guarantee



Trafo met 3 jaar garantie



trasformatore con 3 anni di garanzia



Trafo mit 3 Jahren Garantie

|  |   |  |   |   |   |
|--|---|--|---|---|---|
|  | transfo protégé contre les projections d'eau                      | Transformer splash-proof   | Trafo geschikt tegen spuitwater                                   | trasformatore protetto da spruzzi d'acqua   | Trafo Spritzwasser geschützt  |
|  | transfo protégé contre les jets d'eau                             | Transformer water-proof  | Trafo geschikt tegen straalwater                                  | trasformatore protetto da getti d'acqua   | Trafo Strahlwasser geschützt  |
|  | transfo torique   | Toroidal transformer   | Ringkertrafo  | trasformatore nucleo di ferrite   | Ringkertrafo  |
|  | transfo gradable avec gradateur à découpage de phase              | Dimmable transformer with phase-cutting on leading edge              | Trafo dimbaar met fase-aansnijdimmer                              | trasformatore regolabile con variatore di tensione a fase interrotta iniziale                     | Trafo Dimmbar mit PhasenANSchnittsdimmer                              |
|  | transfo gradable avec gradateur à découpage de phase              | Dimmable transformer with phase-cutting on trailing edge             | Trafo dimbaar met fase-afsnijdimmer                               | trasformatore regolabile con variatore di tensione a fase interrotta finale                       | Trafo Dimmbar mit PhasenABSchnittsdimmer                              |
|  | transfo gradable avec gradateur conventionnel                     | Transformer dimmable with all commercial dimmers                     | Trafo dimbaar , geschikt voor alle beschikbare dimmers            | trasformatore regolabile con tutti i variatori di tensione d'uso commerciale                      | Trafo Dimmbar mit allen handelsüblichen Dimmern                       |
|  | transfo avec gradateur tactile intégré                            | Transformer with integrated sensor Touch dimmer                      | Trafo met ingebouwde sensor-touch dimmer                          | trasformatore con variatore di tensione Sensor-Touch integrato                                    | Trafo mit integriertem Sensor-Touch-Dimmer                            |
|  | transfo gradable avec potentiomètre connecté                      | Transformer with connected potentiometer                             | Trafo dimbaar met aangesloten pot-meter                           | trasformatore regolabile con potenziometro collegato  | Trafo Dimmbar mit angeschlossenem Potentiometer                       |
|  | transfo avec antiparasitage intégré                               | Transformer with integrated spike protection                         | Trafo met ingebouwde radio-ontstoring                             | trasformatore con protezione contro scintille integrata   | Trafo mit integriertem Funkschutz                                     |
|  | transfo avec certification européenne                             | Transformer with European test symbol                                | Trafo met Europees Keurmerk                                       | trasformatore con marchio di controllo europeo  | Trafo mit Europäischem Prüfzeichen                                    |
|  | transfo avec certification VDE                                    | Transformer with test symbol of German electrotechnical union.       | Trafo met VDE-keurmerk  | trasformatore con marchio di controllo dell'associazione tedesca elettrotecnici                   | Trafo mit Prüfzeichen des Verband Deutscher Elektrotechniker          |
|  | transfo avec certification installation meuble                    | Transformer with safety symbol for use with furniture                | Trafo met keurmerk van meubelinbouw                               | trasformatore con marchio di sicurezza per l'installazione su mobili                              | Trafo mit Sicherheitszeichen für Möbeleinbau                          |
|  | transfo avec softstart intégré                                    | Transformer with integrated soft-start                               | Trafo met ingebouwde softstart                                    | trasformatore con softstart integrato   | Trafo mit integriertem Softstart                                      |
|  | transfo avec protection court-circuit intégrée                    | Transformer with integrated short-circuit protection                 | Trafo met ingebouwde kortsluitings-beveiliging                    | trasformatore con protezione contro corto circuito integrata                                      | Trafo mit integriertem Kurzschluss- Schutz                            |
|  | transfo équipé d'une protection pic de tension                    | Transformer includes greater spike protection                        | Trafo met ingebouwde stroomstootbeveiliging                       | trasformatore con elevata protezione da sbalzi di tensione  | Trafo beinhaltet einen erhöhten Spikeschutz                           |
|  | transfo avec fusible électronique intégré                         | Transformer with integrated electronic fuse                          | Trafo met ingebouwde elektronische zekering                       | trasformatore con valvola di sicurezza elettronica integrata                                      | Trafo mit integrierter elektronischer Sicherung                       |
|  | transfo extra-plat  | Extremely flat shape   | Trafo extreem vlak model  | trasformatore a forma estremamente piatta   | Trafo in extrem flache Bauform  |
|  | transfo avec protection incendie intégrée                         | Transformer with integrated fire protection                          | Trafo met ingebouwde brandbeveiliging                             | trasformatore con protezione antincendio integrata  | Trafo mit integriertem Brandschutz                                    |
|  | transfo avec interrupteur thermique réamorçable                   | Transformer with integrated temperature guardian                     | Trafo met ingebouwde en schakelbare temperatuurbewaker            | trasformatore con protezione contro surriscaldamento riattivabile integrata                       | Trafo mit integriertem wiedereinschaltbarem Temperaturwächter         |
|  | transfo avec connexion secondaire rapide                          | Transformer with plug on secondary side                              | Trafo met secundaire stekkeraansluiting                           | trasformatore con collegamento a spina secondario laterale  | Trafo mit Sekundärseitigem Steckeranschluss                           |
|  | transfo avec fiche euro   | Transformer with Euro plug   | Trafo met Eurostekker   | trasformatore con spina Euro  | Trafo mit Eurostecker   |
|  | transfo avec interrupteur intermédiaire                           | Transformer with switch  | Trafo met tussenschakelaar  | trasformatore con interruttore intermedio   | Trafo mit Zwischenschalter  |
|  | transfo fiche avec interrupteur                                   | Plug-in transformer with switch                                      | Stekkertrafo met tussenschakelaar                                 | trasformatore a spina con interruttore intermedio   | Stekkertrafo mit Zwischenschalter                                     |
|  | transfo avec protection surcharge intégrée                        | Transformer with integrated overload protection                      | Trafo met ingebouwde overwattage-beveiliging                      | trasformatore con protezione contro sovraccarico integrata  | Trafo mit integriertem Überlastschutz                                 |
|  | transfo avec protection thermique et fusible électronique intégré | Transformer with integrated temperature guardian and electronic fuse | Trafo met ingebouwde temperatuurbewaker en elektronische zekering | trasformatore con protezione contro surriscaldamento integrata e valvola di sicurezza elettronica | Trafo mit integriertem Temperaturwächter und elektronischer Sicherung |
|  | transfo avec fusible intégré                                      | Transformer with integrated fine fuse                                | Trafo met ingebouwde fijnzekering                                 | trasformatore con fusibile integrato  | Trafo mit integrierter Feinsicherung                                  |



**Transfo électronique Disc VDE 230/12V**  
**VDE Electronic Disc Transformer 230/12V**  
**VDE Disc elektronische trafo 230/12V**  
**Trasformatore elettronico Disc VDE 230/12V**  
**VDE Disc-Electronic-Trafo 230/12V**

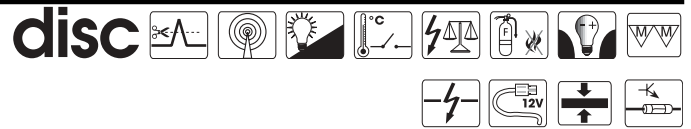

*blanc, white, wit, bianco, weiß*

|      |          |        |   |        |         |
|------|----------|--------|---|--------|---------|
| 50VA | Ø47x18mm | 20-50W | 1 | 977.84 | 97784.2 |
|------|----------|--------|---|--------|---------|



**Transfo électronique Disc ENEC VDE 230/12V**  
**ENEC VDE Electronic Disc transformer 230/12V**  
**ENEC VDE Disc elektronisch trafo 230/12V**  
**Trasformatore elettronico Disc ENEC VDE 230/12V**  
**ENEC VDE Disc-Electronic-Trafo 230/12V**

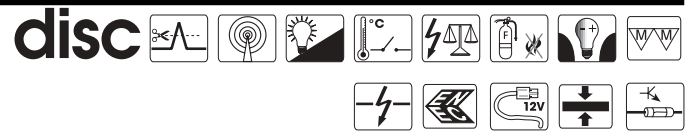

*blanc, white, wit, bianco, weiß*

|       |          |         |   |        |         |
|-------|----------|---------|---|--------|---------|
| 70VA  | Ø53x22mm | 20-70W  | 1 | 977.28 | 97728.6 |
| 105VA | Ø71x22mm | 35-105W | 1 | 977.29 | 97729.3 |



**Transfo électronique Disc ENEC VDE, avec alimentation fiche euro 230/12V**  
**ENEC VDE Electronic Disc transformer, with europlug 230/12V**  
**ENEC VDE Disc elektronisch trafo, met Eurostekker 230/12V**  
**Trasformatore elettronico Disc ENEC VDE, con spina Euro 230/12V**  
**ENEC VDE Disc-Electronic-Trafo, mit Eurostecker 230/12V**

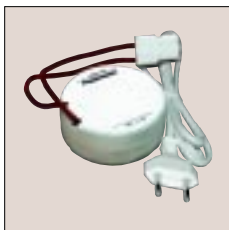
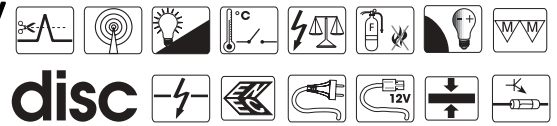

*blanc, white, wit, bianco, weiß*

|       |          |         |   |        |         |
|-------|----------|---------|---|--------|---------|
| 70VA  | Ø53x22mm | 20-70W  | 1 | 977.30 | 97730.9 |
| 105VA | Ø71x22mm | 35-105W | 1 | 977.31 | 97731.6 |



**Transfo 70VA**  
 53mmØ x 22mm  
 Ø 54mm

**Transfo 105VA**  
 71mmØ x 22mm  
 Ø 72mm

**disc**

**DVE**

**3 GARANTIE**

3 Jahre + Arbeit + Material + 2000  
 Ausgarantieren Leuchtarmen  
 Lampenleuchten + alle Lampen  
 ab 1000,- €



**Transfo électronique TIP VDE 230/12V**  
**TIP VDE electronic transformer 230/12V**  
**TIP VDE elektronische trafo 230/12V**  
**Trasformatore elettronico TIP VDE 230/12V**  
**TIP VDE Electronic-Trafo 230/12V**

TIP



blanc, white, wit, bianco, weiß



|       |             |         |   |        |         |
|-------|-------------|---------|---|--------|---------|
| 70VA  | 112x38x28mm | 20-70W  | 1 | 977.87 | 97787.3 |
| 105VA | 112x38x28mm | 20-105W | 1 | 977.88 | 97788.0 |
| 150VA | 165x46x34mm | 30-150W | 1 | 977.89 | 97789.7 |

**Transfo électronique ECO VDE 230/12V**  
**ECO VDE electronic transformer 230/12V**  
**ECO-VDE elektronische trafo 230/12V**  
**Trasformatore elettronico ECO VDE 230/12V**  
**TIP-ECO VDE Electronic-Trafo 230/12V**

TIP



blanc, white, wit, bianco, weiß



|       |             |         |   |        |         |
|-------|-------------|---------|---|--------|---------|
| 80VA  | 112x38x28mm | 20-80W  | 1 | 977.72 | 97772.9 |
| 105VA | 112x38x28mm | 20-105W | 1 | 977.02 | 97702.6 |
| 150VA | 163x45x35mm | 75-150W | 1 | 977.16 | 97716.3 |

**Transfo électronique Mipro VDE 230/12V**  
**VDE Mipro Electronic Transformer 230/12V**  
**VDE elektronische Miprotransformator 230/12V**  
**Trasformatore elettronico Mipro VDE 230/12V**  
**VDE Mipro-Electronic-Trafo 230/12V**

MIPRO

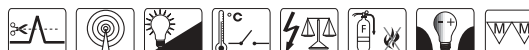

blanc, white, wit, bianco, weiß



|      |             |        |   |        |         |
|------|-------------|--------|---|--------|---------|
| 70VA | 107x33x21mm | 20-70W | 1 | 977.51 | 97751.4 |
|------|-------------|--------|---|--------|---------|



blanc, white, wit, bianco, weiß



|       |             |         |   |        |         |
|-------|-------------|---------|---|--------|---------|
| 80VA  | 112x38x28mm | 20-80W  | 1 | 977.54 | 97754.5 |
| 105VA | 112x38x28mm | 20-105W | 1 | 977.53 | 97753.8 |



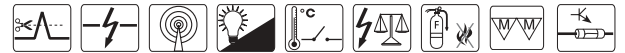
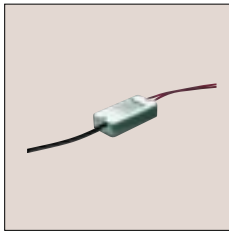

**Transfo électronique Profi VDE 230/12V**  
**VDE Profi Electronic transformer 230/12V**  
**VDE elektronische Profitransformator 230/12V**  
**Trasformatore elettronico Profi VDE 230/12V**  
**VDE Profi-Electronic-Trafo 230/12V**

**PROFI***blanc, white, wit, bianco, weiß*

|      |              |        |   |        |         |
|------|--------------|--------|---|--------|---------|
| 50VA | 76x35,5x19mm | 10-50W | 1 | 977.36 | 97736.1 |
|------|--------------|--------|---|--------|---------|

*blanc, white, wit, bianco, weiß*

|       |             |         |   |        |         |
|-------|-------------|---------|---|--------|---------|
| 80VA  | 133x38x28mm | 20-80W  | 1 | 977.71 | 97771.2 |
| 105VA | 133x38x28mm | 20-105W | 1 | 977.01 | 97701.9 |
| 150VA | 185x46x38mm | 75-150W | 1 | 977.15 | 97715.6 |

*blanc, white, wit, bianco, weiß*

|       |             |          |   |        |         |
|-------|-------------|----------|---|--------|---------|
| 200VA | 185x46x38mm | 100-200W | 1 | 977.20 | 97720.0 |
| 250VA | 226x50x40mm | 100-250W | 1 | 977.25 | 97725.5 |

**Transfo électronique Euro extra-plat VDE 230/12V**  
**VDE Euro Electronic Flat transformer 230/12V**  
**VDE platte elektronische Eurotransformator 230/12V**  
**Trasformatore elettronico piatto Euro VDE 230/12V**  
**VDE Euro-Electronic-Flachtrafo 230/12V**

**EURO***blanc, white, wit, bianco, weiß*

|       |             |         |   |        |         |
|-------|-------------|---------|---|--------|---------|
| 70VA  | 141x55x20mm | 20-70W  | 1 | 977.81 | 97781.1 |
| 105VA | 141x55x20mm | 35-105W | 1 | 977.82 | 97782.8 |
| 120VA | 141x55x20mm | 20-120W | 1 | 977.83 | 97783.5 |

**Transfo électronique Poti VDE 230/12V**  
**VDE Poti Electronic Transformer 230/12V**  
**VDE elektronische Potitransformator 230/12V**  
**Trasformatore elettronico Poti VDE 230/12V**  
**VDE Poti-Electronic-Trafo 230/12V**

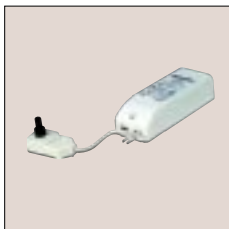
**POTI***blanc, white, wit, bianco, weiß*

|       |             |         |   |        |         |
|-------|-------------|---------|---|--------|---------|
| 70VA  | 112x38x28mm | 20-70W  | 1 | 977.90 | 97790.3 |
| 105VA | 112x38x28mm | 20-105W | 1 | 977.91 | 97791.0 |

*blanc, white, wit, bianco, weiß*

|       |             |         |   |        |         |
|-------|-------------|---------|---|--------|---------|
| 150VA | 165x46x34mm | 30-150W | 1 | 977.92 | 97792.7 |
|-------|-------------|---------|---|--------|---------|



**Transfo électronique Dimm-Touch VDE 230/12V**  
**VDE Dimm-Touchi Electronic transformer 230/12V**  
**VDE elektronische Dimm-Touch transformator 230/12V**  
**Trasformatore elettronico Dimm-Touch VDE 230/12V**  
**VDE Dimm-Touch-Electronic-Trafo 230/12V**

**TOUCH***blanc, white, wit, bianco, weiß*

|       |             |         |   |        |         |
|-------|-------------|---------|---|--------|---------|
| 70VA  | 190x49x40mm | 20-70W  | 1 | 977.93 | 97793.4 |
| 105VA | 190x49x40mm | 20-105W | 1 | 977.94 | 97794.1 |
| 150VA | 190x49x40mm | 50-150W | 1 | 977.95 | 97795.8 |



**TOUCH T**  
**Electronic**  
**TRANSFO-HALOGEN 12V**

**3**  
 Jahre + 1 Jahr + 1 Jahr + 1 Jahr  
 ausgenommen Leuchtmittel  
 empfindlich gegenüber Stößen  
 und geräuschlos bei Betrieb

**GARANTIE**

**DVE**

**Touch**



**IP44 Transfo électronique VDE 230/12V**  
**VDE IP44 electronic transformer 230/12V**  
**VDE IP44 elektronische trafo 230/12V**  
**Trasformatore IP44 elettronico VDE 230/12V**  
**VDE IP44 Electronic-Trafo 230/12V**



**IP44**



*blanc, white, wit, bianco, weiß*

|       |             |         |   |        |         |
|-------|-------------|---------|---|--------|---------|
| 70VA  | 144x56x20mm | 20-70W  | 1 | 977.96 | 97796.5 |
| 105VA | 144x56x20mm | 20-105W | 1 | 977.97 | 97797.2 |



**Transfo IP65, avec alimentation 2m, câblage secondaire 0,8m 230/12V**  
**IP65 transformer, with 2m cable, secondary 0,8m 230/12V**  
**IP65 trafo, kabellengte 2 mtr, secondaire kabel 0,8m 230/12V**  
**Trasformatore IP65, con 2m condotto, secondario 0,8m 230/12V**  
**IP65 Trafo, mit Zuleitung 2m, Sekundär 0,8m 230/12V**



**IP65**



*noir, black, zwart, nero, schwarz*

|       |             |      |   |        |         |
|-------|-------------|------|---|--------|---------|
| 60VA  | 100x71x60mm | 60W  | 1 | 977.85 | 97785.9 |
| 105VA | 110x78x78mm | 105W | 1 | 977.86 | 97786.6 |

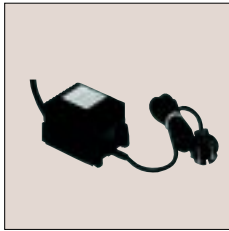

**Transfo universel VDE 230/12V**  
**VDE Universal transformer 230/12V**  
**universeeltransformator VDE 230/12V**  
**Trasformatore universale VDE 230/12V**  
**VDE Universaltrafo 230/12V**



**Universal**



*blanc, white, wit, bianco, weiß*

|       |             |      |   |        |         |
|-------|-------------|------|---|--------|---------|
| 40VA  | 165x46x39mm | 40W  | 1 | 979.42 | 97942.6 |
| 60VA  | 192x49x35mm | 60W  | 1 | 979.62 | 97962.4 |
| 105VA | 248x49x35mm | 105W | 1 | 979.02 | 97902.0 |





**Transfo de sécurité VDE 230/12V**  
**VDE Safety transformer 230/12V**  
**transformator VDE 230/12V**  
**Trasformatore di sicurezza VDE 230/12V**  
**VDE Sicherheitstrafo 230/12V**

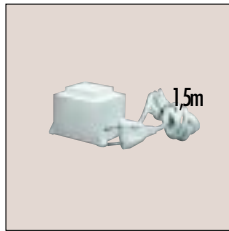

*blanc, white, wit, bianco, weiß*

|      |            |     |   |        |         |
|------|------------|-----|---|--------|---------|
| 60VA | 88x61x63mm | 60W | 1 | 979.60 | 97960.0 |
|------|------------|-----|---|--------|---------|

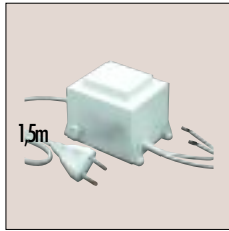

*blanc, white, wit, bianco, weiß*

|       |              |      |   |        |         |
|-------|--------------|------|---|--------|---------|
| 105VA | 109x82x77mm  | 105W | 1 | 979.11 | 97911.2 |
| 150VA | 109x82x77mm  | 150W | 1 | 979.15 | 97915.0 |
| 200VA | 130x92x101mm | 200W | 1 | 979.20 | 97920.4 |
| 300VA | 130x92x101mm | 300W | 1 | 979.30 | 97930.3 |



*blanc, white, wit, bianco, weiß*

|       |               |      |   |         |         |
|-------|---------------|------|---|---------|---------|
| 400VA | 177x107x129mm | 400W | 1 | 979.40  | 97940.2 |
| 500VA | 177x107x129mm | 500W | 1 | 979.500 | 97952.5 |



**Transfo déco de sécurité VDE 230/12V**  
**VDE Decorative safety transformer 230/12V**  
**VDE Dekotrafo 230/12V**  
**Trasformatore di sicurezza VDE Deko 230/12V**  
**VDE Deko-Sicherheitstrafo 230/12V**



*blanc, white, wit, bianco, weiß*

|       |              |      |   |        |         |
|-------|--------------|------|---|--------|---------|
| 150VA | 190x95x80mm  | 150W | 1 | 979.56 | 97956.3 |
| 200VA | 240x120x90mm | 200W | 1 | 979.26 | 97926.6 |
| 300VA | 240x120x90mm | 300W | 1 | 979.36 | 97936.5 |

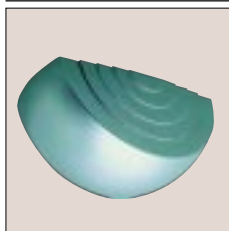

*alu brossé, alu matt, alu mat, color alluminio opaco, alu matt*

|       |              |      |   |        |         |
|-------|--------------|------|---|--------|---------|
| 200VA | 240x120x90mm | 200W | 1 | 979.78 | 97978.5 |
| 300VA | 240x120x90mm | 300W | 1 | 979.79 | 97979.2 |



**Transfo Déco torique 230/12V**  
**Toroidal decorative transformer 230/12V**  
**Toroidal-Dekotrafo 230/12V**  
**Trasformatore Deko Toroidal 230/12V**  
**Toroidal-Dekotrafo 230/12V**



*alu brossé, alu matt, alu mat, color alluminio opaco, alu matt*

|       |            |      |   |        |         |
|-------|------------|------|---|--------|---------|
| 150VA | Ø160x110mm | 150W | 1 | 960.39 | 96039.4 |
| 200VA | Ø160x110mm | 200W | 1 | 960.40 | 96040.0 |
| 300VA | Ø160x110mm | 300W | 1 | 960.41 | 96041.7 |





**Transfo électronique Sinus VDE 230/12V**  
**VDE Sinus Electronic Transformer 230/12V**  
**VDE elektronische Sinus-Trafo 230/12V**  
**Trasformatore elettronico VDE Sinus 230/12V**  
**VDE Sinus-Electronic-Trafo 230/12V**

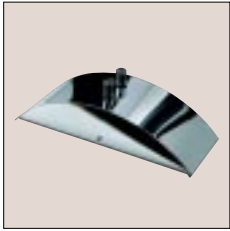

*chrome, chrome, chroom, cromo, chrom*

150VA 230x85x79mm 50-150W

1

960.01

96001.1



**Transfo Euro VDE 230/12V**  
**VDE Euro transformer 230/12V**  
**VDE Euro-Trafo 230/12V**  
**Trasformatore VDE Euro 230/12V**  
**VDE Euro-Trafo 230/12V**

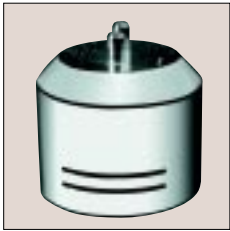

*chrome, chrome, chroom, cromo, chrom*

150VA Ø120x112mm 150W

1

960.09

96009.7



**transfo fiche TÜV 230/12V**  
**TÜV plug-in transformer 230/12V**  
**TÜV-Steckertrafo 230/12V**  
**Trasformatore a spina TÜV 230/12V**  
**TÜV-Steckertrafo 230/12V**

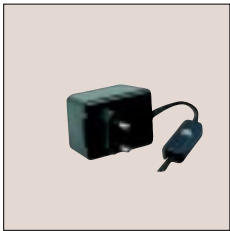

*noir, black, zwart, nero, schwarz*

20VA - 20W

1

979.22

97922.8



**transfo électronique VDE 230/12V**  
**VDE Electronic transformer 230/12V**  
**VDE elektronische trafo 230/12V**  
**Trasformatore elettronico VDE 230/12V**  
**VDE-Electronic-Stecker-Trafo 230/12V**



*noir, black, zwart, nero, schwarz*

50VA - 20-50W

1

979.51

97953.2

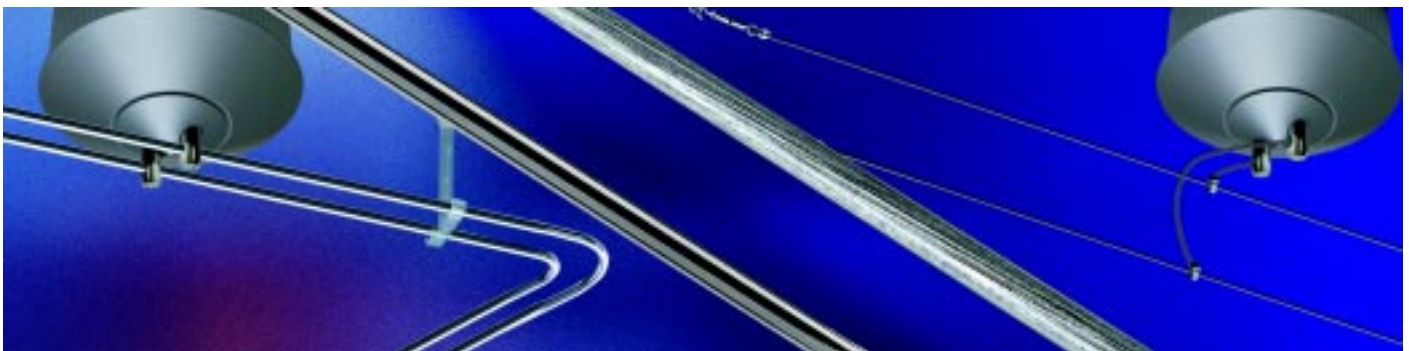



**Capot décoratif Pyramide**  
**Pyramid Decorative Cover**  
**Pyramide Dekokap**  
**Calotta a piramide Deko**  
**Pyramide Deko-Haube**

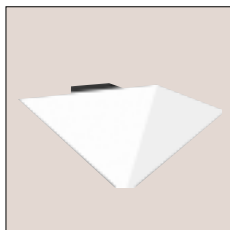

*blanc, white, wit, bianco, weiß*

20-300VA 255x255x151mm - 1 **979.33** 97933.4

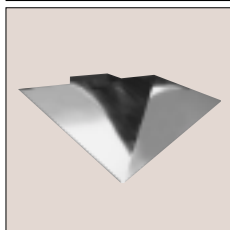

*chrome, chrome, chroom, cromo, chrom*

20-300VA 255x255x151mm - 1 **979.38** 97938.9

**Fusibles, Pack de 3**  
**Fine fuses, Pack of 3**  
**zekeringen, 3 stuks**  
**Fusibili, confezione da 3**  
**Feinsicherungen, 3er-Pack**



*clair, clear, helder, chiaro, klar*

|       |   |           |   |   |                 |         |
|-------|---|-----------|---|---|-----------------|---------|
| 105VA | - | 0,63 Amp. | ✓ | 4 | <b>979.9969</b> | 00766.2 |
| 150VA | - | 1 Amp.    | ✓ | 4 | <b>979.9919</b> | 97919.8 |
| 150VA | - | 1,25 Amp. | ✓ | 1 | <b>979.12</b>   | 97912.9 |
| 200VA | - | 1,6 Amp.  | ✓ | 4 | <b>979.9929</b> | 97929.7 |
| 300VA | - | 2 Amp.    | ✓ | 4 | <b>979.9939</b> | 97939.6 |
| 400VA | - | 2,5 Amp.  | ✓ | 4 | <b>979.9979</b> | 00767.9 |
| 500VA | - | 3,15 Amp. | ✓ | 4 | <b>979.9949</b> | 00641.2 |
| -     | - | 5 Amp.    | ✓ | 4 | <b>979.9989</b> | 00643.6 |



**Gradateur à pied pour ampoules**  
**Foot dimmer for incandescent lamps**  
**voetdimmer voor gloeilampen**  
**Variatore di tensione a piede per lampadine**  
**Fußdimmer für Glühlampen**



*noir, black, zwart, nero, schwarz*

|             |   |   |        |         |
|-------------|---|---|--------|---------|
| 145x47x38mm | - | 1 | 977.04 | 97704.0 |
|-------------|---|---|--------|---------|

**Gradateur pour ampoules**  
**Wire dimmer for incandescent lamps**  
**snoerdimmer voor gloeilampen**  
**Variatore di tensione a filo per lampadine incandescenti**  
**Schnurdimmer für Glühlampen**



*noir, black, zwart, nero, schwarz*

|   |      |   |        |         |
|---|------|---|--------|---------|
| - | 95mm | 1 | 977.05 | 97705.7 |
|---|------|---|--------|---------|

*transparent, transparent, transparant, trasparente, transparent*

|   |      |   |        |         |
|---|------|---|--------|---------|
| - | 95mm | 1 | 977.07 | 97707.1 |
|---|------|---|--------|---------|



*noir, black, zwart, nero, schwarz*

|   |      |   |        |         |
|---|------|---|--------|---------|
| - | 90mm | 1 | 977.08 | 97708.8 |
|---|------|---|--------|---------|

*blanc, white, wit, bianco, weiß*

|   |      |   |        |         |
|---|------|---|--------|---------|
| - | 90mm | 1 | 977.09 | 97709.5 |
|---|------|---|--------|---------|

**Capuchon décoratif**  
**Decorative Cap**  
**Dekokap**  
**Copertura Deko**  
**Deko-Kappe**



*satin, satin, satijn, satinato, satin*

|   |      |   |   |        |         |
|---|------|---|---|--------|---------|
| - | 86mm | ✓ | 1 | 178.50 | 17850.8 |
|---|------|---|---|--------|---------|

*bleu, blue, blauw, blu, blau*

|   |      |   |   |        |         |
|---|------|---|---|--------|---------|
| - | 86mm | ✓ | 1 | 178.51 | 17851.5 |
|---|------|---|---|--------|---------|

*chrome, chrome, chroom, cromo, chrom*

|   |      |   |   |        |         |
|---|------|---|---|--------|---------|
| - | 80mm | ✓ | 1 | 178.48 | 17848.5 |
|---|------|---|---|--------|---------|

**No. 178.50**



**No. 178.51**

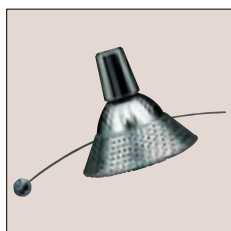

**No. 178.48**

**Filtre disco avec anneau de fixation**  
**Disco front glass with decorative ring**  
**Discoschijfje, met ring**  
**Vetro anteriore Disco, con cerchio decorativo**  
**Disco-Vorsatzscheibe, mit Schmuckring**



rouge, red, rood, rosso, rot

|   |      |   |   |   |        |         |
|---|------|---|---|---|--------|---------|
| - | 51mm | - | ✓ | 5 | 833.91 | 83391.9 |
|---|------|---|---|---|--------|---------|



jaune, yellow, geel, giallo, gelb

|   |      |   |   |   |        |         |
|---|------|---|---|---|--------|---------|
| - | 51mm | - | ✓ | 5 | 833.92 | 83392.6 |
|---|------|---|---|---|--------|---------|

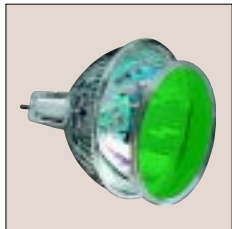

vert, green, groen, verde, grün

|   |      |   |   |   |        |         |
|---|------|---|---|---|--------|---------|
| - | 51mm | - | ✓ | 5 | 833.93 | 83393.3 |
|---|------|---|---|---|--------|---------|



bleu, blue, blauw, blu, blau

|   |      |   |   |   |        |         |
|---|------|---|---|---|--------|---------|
| - | 51mm | - | ✓ | 5 | 833.94 | 83394.0 |
|---|------|---|---|---|--------|---------|

**Boîtier port lampe Telly, pour câble et rail, pack de 3**  
**Telly lamp-holder, for wire and track systems, pack of three**  
**Telly-lampenhouder, voor kabel- en staafsystemen, 3-pack**  
**Portalampada Telly, per sistemi modulari e ad asta, confezione da 3**  
**Telly-Lampenhalter, für Seil- und Stabsysteme, 3er-Pack**

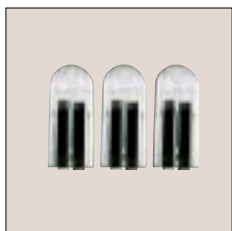

clair transparent, clear transparent, helder transparant, chiaro trasparente, klar transparent

|     |   |          |  |   |        |         |
|-----|---|----------|--|---|--------|---------|
| 35W | - | G4+GX5,3 |  | 1 | 178.63 | 17863.8 |
|-----|---|----------|--|---|--------|---------|

**Boîtier porte ampoule Kolibri, pour système sur câble**  
**Kolibri lamp-holder, for wire systems**  
**Haribo lampenhouder, voor spankabelsystemen**  
**Supporto Kolibri per lampadine, per sistemi modulari**  
**Kolibri Lampenhalter, für Seilsysteme**



blanc, white, wit, bianco, weiß

|     |   |       |   |    |        |         |
|-----|---|-------|---|----|--------|---------|
| 50W | - | GX5,3 | ✓ | 10 | 975.16 | 97516.9 |
|-----|---|-------|---|----|--------|---------|

noir, black, zwart, nero, schwarz

|     |   |       |   |    |        |         |
|-----|---|-------|---|----|--------|---------|
| 50W | - | GX5,3 | ✓ | 10 | 975.17 | 97517.6 |
|-----|---|-------|---|----|--------|---------|

**Boîtier porte ampoule Haribo, pour système sur câble**  
**Haribo lamp-holder, for wire systems**  
**Haribo lampenhouder, voor spankabelsystemen**  
**Supporto Haribo per lampadine, per sistemi modulari**  
**Haribo Lampenhalter, für Seilssysteme**



*blanc, white, wit, bianco, weiß*

|     |       |   |   |   |        |         |
|-----|-------|---|---|---|--------|---------|
| 50W | GX5,3 | - | ✓ | 4 | 978.44 | 97844.3 |
|-----|-------|---|---|---|--------|---------|

*noir, black, zwart, nero, schwarz*

|     |       |   |   |   |        |         |
|-----|-------|---|---|---|--------|---------|
| 50W | GX5,3 | - | ✓ | 4 | 978.45 | 97845.0 |
|-----|-------|---|---|---|--------|---------|

|     |    |   |   |   |        |         |
|-----|----|---|---|---|--------|---------|
| 35W | G4 | - | ✓ | 4 | 978.41 | 97841.2 |
|-----|----|---|---|---|--------|---------|

**Sabot-contact pour système sur câble**  
**Cable Block for Wire Systems**  
**kabelklosje voor spankabelsystemen**  
**Cilindro bloccaggio cavo per sistemi modulari**  
**Seilklotz für Seilssysteme**

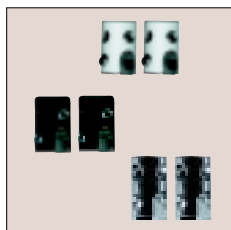

*blanc, white, wit, bianco, weiß*

|      |     |   |   |   |        |         |
|------|-----|---|---|---|--------|---------|
| 150W | 2 x | - | ✓ | 4 | 978.33 | 97833.7 |
|------|-----|---|---|---|--------|---------|

*noir, black, zwart, nero, schwarz*

|      |     |   |   |   |        |         |
|------|-----|---|---|---|--------|---------|
| 150W | 2 x | - | ✓ | 4 | 978.31 | 97831.3 |
|------|-----|---|---|---|--------|---------|

*chrome, chrome, chroom, cromo, chrom*

|      |     |   |   |   |         |         |
|------|-----|---|---|---|---------|---------|
| 150W | 2 x | - | ✓ | 4 | 978.019 | 97819.1 |
|------|-----|---|---|---|---------|---------|

|      |     |   |  |   |        |         |
|------|-----|---|--|---|--------|---------|
| 150W | 6 x | - |  | 1 | 978.01 | 97801.6 |
|------|-----|---|--|---|--------|---------|

**Attache-boucle ou contact d'alimentation pour système sur câble**  
**Safety Cable Connector for providing current in wire systems**  
**kabelklemmen, voor stroomvoeding naar spankabelsystemen**  
**Morsetto di sicurezza, per l'alimentazione di corrente nei sistemi modulari**  
**Sicherheits-Seilklemme, für Stromeinspeisung im Seilssystem**

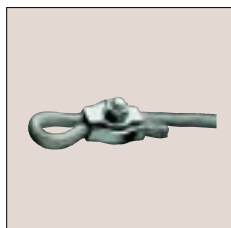

*chrome, chrome, chroom, cromo, chrom*

|      |     |   |   |   |         |         |
|------|-----|---|---|---|---------|---------|
| 300W | 2 x | - | ✓ | 4 | 978.029 | 97829.0 |
|------|-----|---|---|---|---------|---------|

|      |      |   |  |   |        |         |
|------|------|---|--|---|--------|---------|
| 300W | 10 x | - |  | 1 | 978.02 | 97802.3 |
|------|------|---|--|---|--------|---------|

**Renvoi d'angle Vario**  
**Vario Cable direction changer, installation set for wire**  
**Vario-spanomleider, montageset voor spankabel verlegging**  
**Diviatore a tensione Vario, set l'installazione per prolungamento della corda**  
**Vario-Spannumlenker, Montageset für Seilverlegung**



*acryl, acryl, acryl, acrilico, acryl*

|   |   |             |   |   |        |         |
|---|---|-------------|---|---|--------|---------|
| - | - | 140x25x25mm | ✓ | 1 | 979.08 | 97908.2 |
|---|---|-------------|---|---|--------|---------|

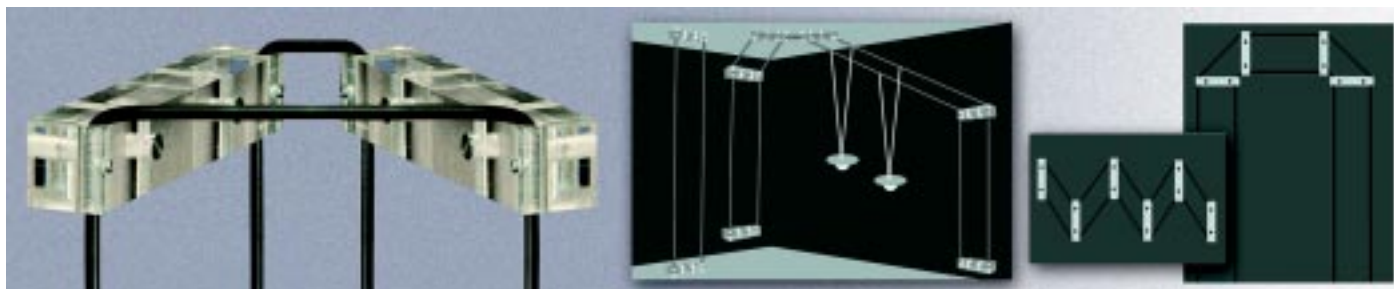

**Tendeur de câble**  
**Cable Holder**  
**kabelspanner**  
**Tenditore corda**  
**Seilspanner**

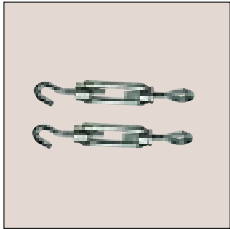

étamé, zink-plated, verzinkt, zincato, verzinkt

|   |   |   |         |         |
|---|---|---|---------|---------|
| - | ✓ | 4 | 978.039 | 97839.9 |
|---|---|---|---------|---------|

**Kit de traction de sécurité non-isolé**  
**Non-insulated Installation Kit**  
**span-/montageset, niet-geïsoleerd**  
**Set per l'installazione e tensione, non isolato**  
**Spann-Montageset, nicht isoliert**

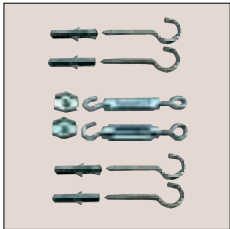

étamé, zink-plated, verzinkt, zincato, verzinkt

|   |   |   |        |         |
|---|---|---|--------|---------|
| - | ✓ | 1 | 979.01 | 97901.3 |
|---|---|---|--------|---------|

**Tendeur de câble**  
**Cable tightener**  
**kabelspanner**  
**Tenditore corda**  
**Seilspanner**

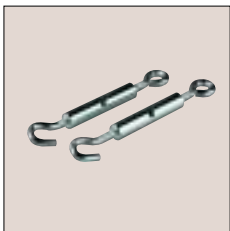

chrome, chrome, chroom, cromo, chrom

|   |   |    |        |         |
|---|---|----|--------|---------|
| - | ✓ | 10 | 178.00 | 17800.3 |
|---|---|----|--------|---------|

**Kit de traction de sécurité non-isolé**  
**Non-insulated Installation Kit**  
**span-/montageset, niet-geïsoleerd**  
**Set per l'installazione e tensione, non isolato**  
**Spann-Montageset, nicht isoliert**



chrome, chrome, chroom, cromo, chrom

|   |   |   |        |         |
|---|---|---|--------|---------|
| - | ✓ | 1 | 178.03 | 17803.4 |
|---|---|---|--------|---------|





**Tendeur mural flexible, 1 paire**  
**Flexible wall cable tightener, 1 pair**  
**wandspanner, flexibel, 1 paar**  
**Tenditore a parete, flessibile, 1 coppia**  
**Wandspanner, flexibel, 1 Paar**



chrome, chrome, chroom, cromo, chrom

|   |      |   |   |        |         |
|---|------|---|---|--------|---------|
| - | 42mm | ✓ | 1 | 178.08 | 17808.9 |
|---|------|---|---|--------|---------|

**Jonction et renvoi mural, 1 paire**  
**Direction changer for wall fitting**  
**wandbevestiging / -omleider, 1 paar**  
**Deviatore con collegamento a parete, 1 coppia**  
**Wandanschluß-Umlenker, 1 Paar**

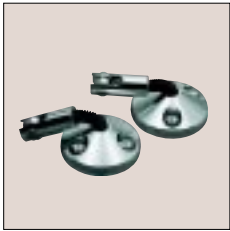

chrome, chrome, chroom, cromo, chrom

|   |      |   |   |        |         |
|---|------|---|---|--------|---------|
| - | 42mm | ✓ | 1 | 178.10 | 17810.2 |
|---|------|---|---|--------|---------|

**Ressort de traction, 1 paire**  
**Spring for wire set, 1 pair**  
**spanveer, 1 paar**  
**Molla di trazione, 1 coppia**  
**Spannfeder, 1 Paar**

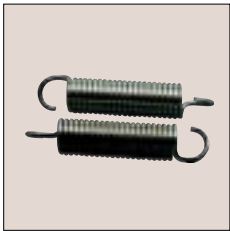

chrome, chrome, chroom, cromo, chrom

|      |      |   |    |        |         |
|------|------|---|----|--------|---------|
| 18mm | 90mm | ✓ | 10 | 178.02 | 17802.7 |
|------|------|---|----|--------|---------|

**Renvoi d'angle à visser, 1 paire**  
**Cable Diverter for ceilings, for use with screws, 1 pair**  
**omleider-plafondbevestiging, schroefbaar, 1 paar**  
**Fissaggio deviatore a soffitto, da avvitare, 1 coppia**  
**Umlenker-Deckenbefestigung, zum Aufschrauben, 1 Paar**



alu, alu, alu, color alluminio, alu

|      |       |   |   |        |         |
|------|-------|---|---|--------|---------|
| 16mm | 165mm | ✓ | 1 | 178.06 | 17806.5 |
|------|-------|---|---|--------|---------|

**Tendeur d'angle**  
**Corner Tightener**  
**hoekspanner**  
**Tenditore ad angolo**  
**Eckspanner**

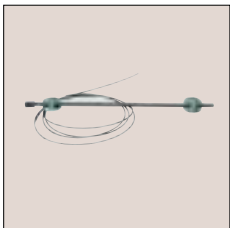

chrome, chrome, chroom, cromo, chrom

|      |          |   |   |        |         |
|------|----------|---|---|--------|---------|
| 12mm | 42-265mm | ✓ | 1 | 178.12 | 17812.6 |
|------|----------|---|---|--------|---------|



**Suspension anti-flèche**  
**Connecting suspenders**  
**Tussenophanging**  
**Attacco intermedio**  
**Zwischenaufhängung**



*acryl, acryl, acryl, acrilico, acryl*

|      |       |   |   |        |         |
|------|-------|---|---|--------|---------|
| 12mm | 170mm | ✓ | 1 | 178.14 | 17814.0 |
|------|-------|---|---|--------|---------|

**No. 178.02**

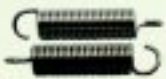

**No. 178.10**



**No. 178.14**



**No. 178.12**



**No. 178.06**



**No. 178.08**



**Jonction murale, 1 paire, avec vis et chevilles**  
**Wall connector, to be screwed, 1 pair, with wall-plug and screw**  
**wandaansluiting, schroefbaar, 1 paar, incl pluggen en schroeven**  
**Collegamento a parete, da avvitare, 1 coppia, con tassello e vite**  
**Wandanschluß, verschraubbar, 1 Paar, mit Dübel + Schraube**

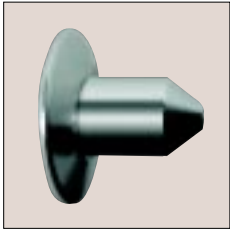

*nickel, nickel, nikkell, color nichel, nickel*

20/45mm 35mm 1 8201 08201.0

**Séparateur de circuit, 1 paire**  
**Current stopper, 1 pair**  
**stroomscheidingsonderdeel, 1 paar**  
**Divisorio circuito elettrico, 1 coppia**  
**Stromkreistrennteil, 1 Paar**

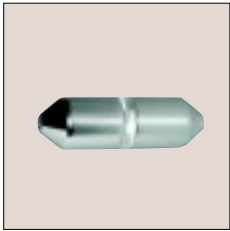

*nickel, nickel, nikkell, color nichel, nickel*

20mm 65mm 1 8200 08200.3

**Jonction murale avec passage de câble, 1 paire, avec vis et chevilles**  
**Wall connector with cable extension, 1 pair, with wall-plugs and screw**  
**wandaansluiting met kabeldoorvoer, 1 paar, incl pluggen en schroeven**  
**Collegamento a parete, con prolunga cavo, 1 coppia, con tassello e vite**  
**Wandanschluß, mit Kabelweiterführung, 1 Paar, mit Dübel + Schraube**



*nickel, nickel, nikkell, color nichel, nickel*

20/45mm 60mm 1 8203 08203.4

**Jonction murale avec ressort de tension, 1 paire, avec vis et chevilles**  
**Spring - wall installation, 1 pair, with wall-plug and screw**  
**spanveer, wandaansluiting, incl. 1 paar, pluggen en schroeven**  
**Collegamento a parete con molla di trazione, 1 coppia, con tassello e vite**  
**Spannfeder-Wandanschluß, 1 Paar, mit Dübel + Schraube**

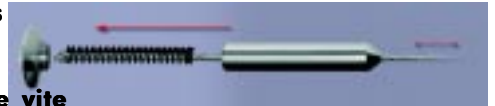

*nickel, nickel, nikkell, color nichel, nickel*

20/45mm 115mm 1 8205 08205.8

**Mini renvoi avec roulette, 1 paire, avec vis et chevilles**  
**Mini diverter 1 pair, with wall-plug and screw**  
**mini katrol omleider, 1 paar, incl pluggen en schroeven**  
**Deviatore mini con rotella, 1 coppia, con tassello e vite**  
**Miniumlenker mit Rolle, 1 Paar, mit Dübel + Schraube**



*nickel, nickel, nikkell, color nichel, nickel*

20/45mm 45mm 1 8207 08207.2



**Renvoi de plafond, 1 paire, angle de renvoi jusqu'à 45°**  
**Ceiling diverter, 1 pair, up to 45° angle**  
**plafondomleider, 1 paar, maximale hoek van 45 graden**  
**Copri deviatore, 1 coppia, inclinazione fino a 45°**  
**Umlenker-Decke, 1 Paar, bis 45° Neigung**

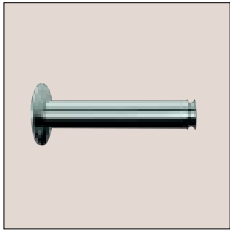

*nickel, nickel, nikkell, color nichel, nickel*

20/45mm

155mm

1

8211

08211.9

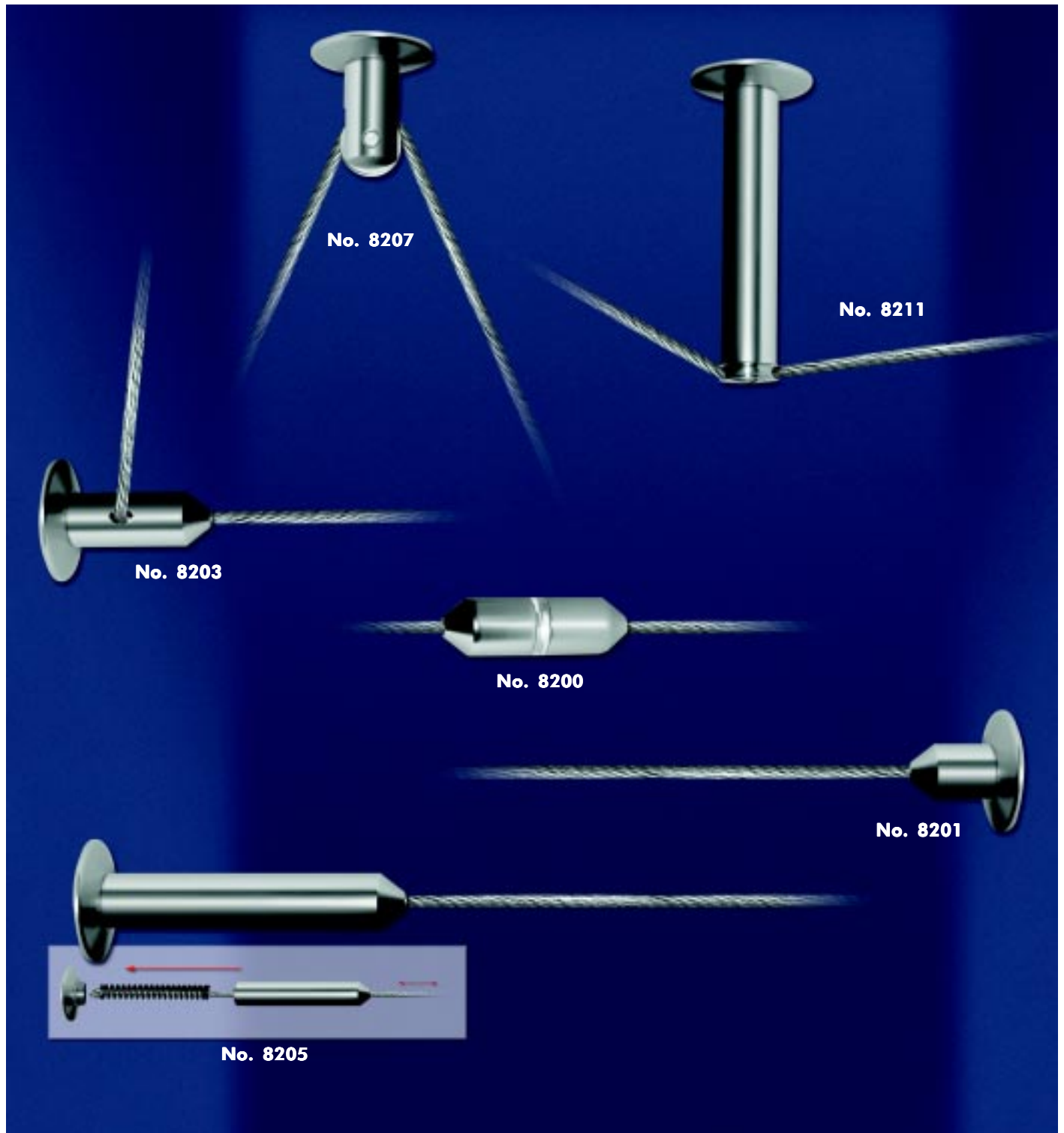

**Kit de traction**  
**Cable installation kit**  
**Spanmontageset**  
**Set per il montaggio e per la tensione**  
**Spann-Montageset**

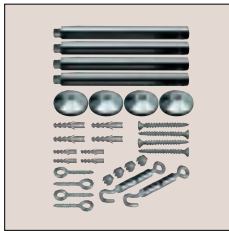

chrome, chrome, chroom, cromo, chrom

|      |       |   |        |         |
|------|-------|---|--------|---------|
| 16mm | 165mm | 1 | 178.34 | 17834.8 |
|------|-------|---|--------|---------|

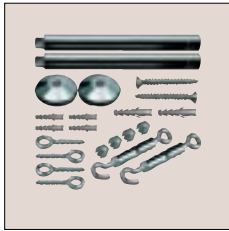

chrome, chrome, chroom, cromo, chrom

|      |       |   |        |         |
|------|-------|---|--------|---------|
| 16mm | 165mm | 1 | 178.35 | 17835.5 |
|------|-------|---|--------|---------|

**Renvoi d'angle à visser, 1 paire**  
**Cable Diverter for ceilings, for use with screws, 1 pair**  
**omleider-plafondbevestiging, schroefbaar, 1 paar**  
**Fissaggio deviatore a soffitto, da avvitare, 1 coppia**  
**Umlenker-Deckenbefestigung, zum Aufschrauben, 1 Paar**

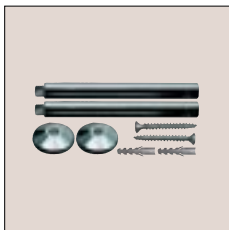

chrome, chrome, chroom, cromo, chrom

|      |       |   |        |         |
|------|-------|---|--------|---------|
| 16mm | 165mm | 1 | 178.24 | 17824.9 |
|------|-------|---|--------|---------|





**Douille halogène universelle pour G4, GX5,3, GY6,36**  
**Halogen lamp-holder, universal, für G4, G\*5,3, GY6,35**  
**halogeen-fitting, universeel, voor G4, GX5,3, GY6,36**  
**Portalampada alogeno, universale, per G4, GX5,3, GY6,36**  
**Halogen-Fassung, universal, für G4, GX5,3, GY6,35**

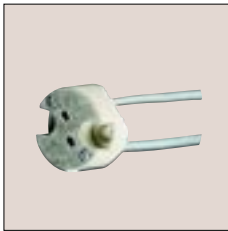

*blanc, white, wit, bianco, weiß*

|   |   |   |   |       |         |
|---|---|---|---|-------|---------|
| - | - |   | 1 | 218   | 00218.6 |
| - | - | ✓ | 4 | 218.9 | 02189.7 |

**Douille halogène 230V, pour ampoules GU10 + GZ10**  
**Halogen high-voltage socket, for GU10 + GZ10 lamps**  
**Halogeen hoogvolt fitting, voor GU10 + GZ10 lampen**  
**Portalampada alogeno ad alta tensione, per lampade GU10 + GZ10**  
**Halogen-Hochvolt-Fassung, für GU10 + GZ10 Lampen**

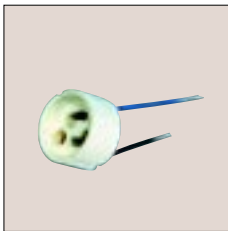

*blanc, white, wit, bianco, weiß*

|   |   |   |   |     |         |
|---|---|---|---|-----|---------|
| - | - | ✓ | 1 | 217 | 00217.9 |
|---|---|---|---|-----|---------|

**Câble de tension de sécurité isolé**  
**Insulated Safety Cable**  
**kabel voor laagspanningsinstallaties, geïsoleerd**  
**Corda di tensione di sicurezza, isolata**  
**Sicherheits-Spannseil, isoliert**



*clair, clear, helder, chiaro, klar*

|     |      |   |   |         |         |
|-----|------|---|---|---------|---------|
| 4mm | 10m  | ✓ | 1 | 979.051 | 97951.8 |
| 4mm | 15m  | ✓ | 1 | 979.061 | 97961.7 |
| 4mm | 100m |   | 1 | 979.057 | 00656.6 |
| 6mm | 10m  | ✓ | 1 | 979.065 | 97965.5 |
| 6mm | 15m  | ✓ | 1 | 979.066 | 97966.2 |
| 6mm | 100m |   | 1 | 979.067 | 00657.3 |

**Câble de tension de sécurité non-isolé**  
**Non-insulated Cable**  
**kabel voor laagspanningsinstallaties, niet-geïsoleerd**  
**Corda di tensione, non isolata**  
**Spannseil, nicht isoliert**



*Zingé, Tin-plated, vertint, stagnato, verzinkt*

|     |      |   |   |        |         |
|-----|------|---|---|--------|---------|
| 4mm | 10m  | ✓ | 1 | 979.05 | 97905.1 |
| 4mm | 100m |   | 1 | 979.29 | 00029.8 |
| 6mm | 100m |   | 1 | 979.13 | 97913.6 |

**Câble double**  
**Double cable**  
**tweelingsnoer**  
**Doppio cavo**  
**Doppelkabel**



*transparent, transparent, transparant, trasparente, transparent*

|                      |     |   |   |          |         |
|----------------------|-----|---|---|----------|---------|
| 2x1,5mm <sup>2</sup> | 10m | ✓ | 1 | 979.0569 | 00648.1 |
| 2x2,5mm <sup>2</sup> | 10m | ✓ | 1 | 979.0529 | 00769.3 |



**Boîtier de distribution avec 6 porte-fusibles**  
**Halogen junction box, including 6 safety holders**  
**haloogen verdeeldoos, incl 6 zekeringhouders, aaneen schakelbaar**  
**Presà di distribuzione alogena, incl. 6 portafusibili, collegabili**  
**Halogen-Verteilerdose, incl. 6 Sicherungshaltern, anreihbar**

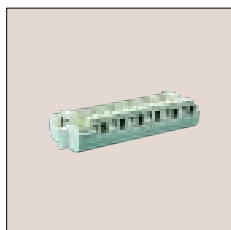

*blanc, white, wit, bianco, weiß*

|   |   |       |   |   |        |         |
|---|---|-------|---|---|--------|---------|
| - | - | 6x50W | ✓ | 4 | 977.70 | 97770.5 |
|---|---|-------|---|---|--------|---------|

**Fusibles, Pack de 3**  
**Fine fuses, Pack of 3**  
**zekeringen, 3 stuks**  
**Fusibili, confezione da 3**  
**Feinsicherungen, 3er-Pack**

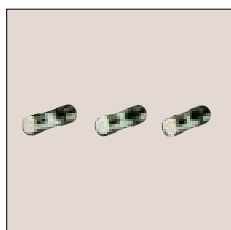

*clair, clear, helder, chiaro, klar*

|           |   |     |   |   |          |         |
|-----------|---|-----|---|---|----------|---------|
| 2 Amp.    | - | 20W | ✓ | 4 | 979.9939 | 97939.6 |
| 3,15 Amp. | - | 35W | ✓ | 4 | 979.9949 | 00641.2 |
| 5 Amp.    | - | 50W | ✓ | 4 | 979.9989 | 00643.6 |

**Porte fusible pour spot individuel, pack de 2, jusqu'à 4mm<sup>2</sup>**  
**Fine fuse holder, for individual lamps, pack of 2, up to 4mm<sup>2</sup>**  
**zekeringshouder, voor armaturen 2-pack, tot 4mm<sup>2</sup>**  
**Supporto per fusibili, per lampade singole, confezione da 2, fino a 4mm<sup>2</sup>**  
**Feinsicherungshalter, für Einzelleuchten, 2er-Pack, bis 4mm<sup>2</sup>**

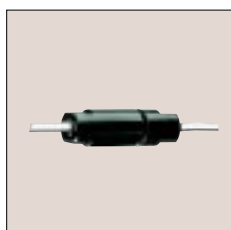

*noir, black, zwart, nero, schwarz*

|   |   |   |   |   |         |         |
|---|---|---|---|---|---------|---------|
| - | - | - | ✓ | 4 | 977.799 | 00755.6 |
|---|---|---|---|---|---------|---------|

**Domino céramique, 4-6mm<sup>2</sup>**  
**Safety ceramic lamp-holder, 4-6mm<sup>2</sup>**  
**keramisch kroonsteentje, 4-6mm<sup>2</sup>**  
**Morsetto di sicurezza di ceramica, 4-6mm<sup>2</sup>**  
**Sicherheits-Keramik-Lüsterklemme, 4-6mm<sup>2</sup>**



*blanc, white, wit, bianco, weiß*

|   |           |   |   |    |         |         |
|---|-----------|---|---|----|---------|---------|
| - | 19,5x21mm | - | ✓ | 10 | 977.759 | 00644.3 |
|---|-----------|---|---|----|---------|---------|

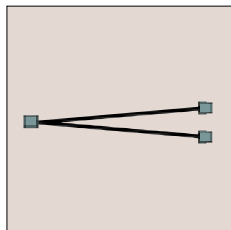
**jeu de câble avec connexions rapides****Cable connectors, with plug****Kabelset met steekverbinding****Gruppo cavi, con attacco a spina****Kabelsätze, mit Steckverbinding**

|              |            |    |        |         |
|--------------|------------|----|--------|---------|
| 2x max. 50W  | 2x200cm    | 1  | 979.82 | 97982.2 |
| 1x max. 105W | 200cm      | 1  | 979.83 | 97983.9 |
| 3x max. 35W  | 50/80/80cm | ✓  | 979.73 | 97973.0 |
| 5x max. 20W  | 130/210cm  | ✓  | 979.75 | 97975.4 |
| 1x max. 150W | 100mm      | 10 | 979.84 | 97984.6 |

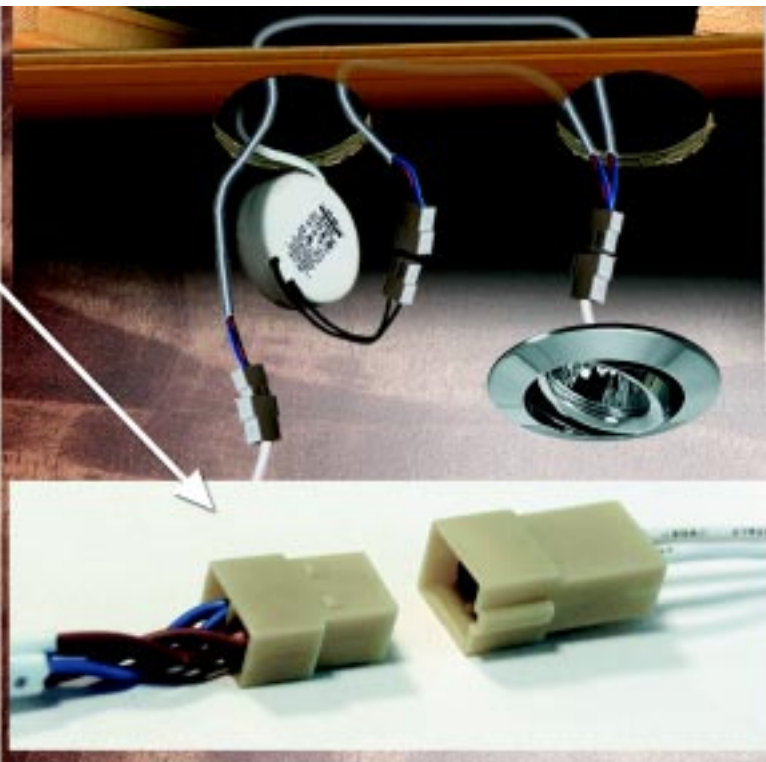
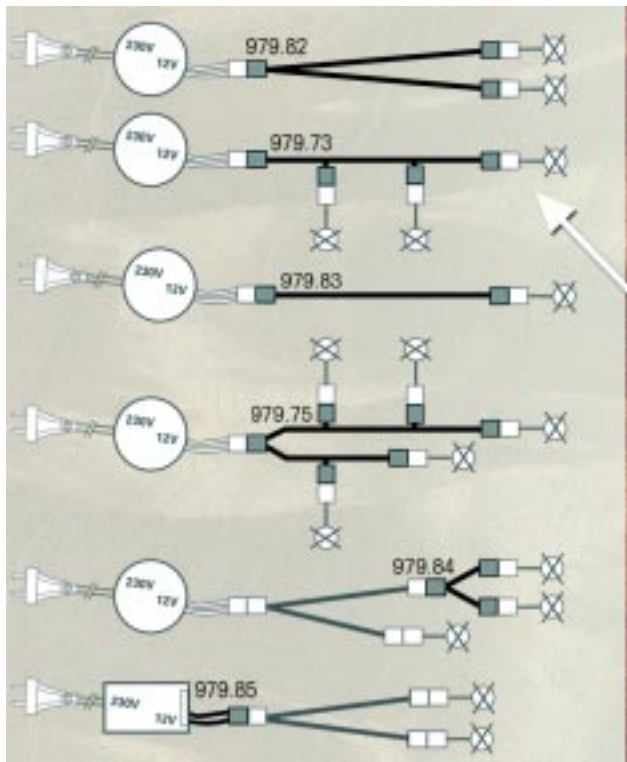
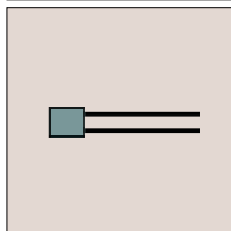
**adaptateur pour transfo avec bornier****Adapter for transformers****Adapter voor trafo's met klemaansluiting****Adattatore per trasformatori con collegamento a molletta****Adapter für Trafos mit Klemmanschluss**

|              |       |    |        |         |
|--------------|-------|----|--------|---------|
| 1x max. 150W | 100mm | 10 | 979.85 | 97985.3 |
|--------------|-------|----|--------|---------|

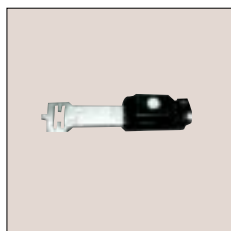
**Patte pour encastré avec arrêt de traction et bornier couvert 12V****Strain relief, with covered lamp-holder 12V****trekontlasting, met afgedekt kroonsteentje 12V****Rinforzo, con morsetto rivestito 12V****Zugentlastung, mit abgedeckter Lüsterklemme 12V**

979.23

97923.5

**Spot mural**  
**Wall-Spot**  
**wandspot**  
**Spot a parete**  
**Wandspot**



*blanc, white, wit, bianco, weiß*

|     |     |    |        |         |
|-----|-----|----|--------|---------|
| 60W | E27 | 25 | 920.30 | 92030.5 |
|-----|-----|----|--------|---------|

**Spot à pince**  
**Clamp Spot**  
**klemspot**  
**Spot morsetti**  
**Klemmspot**



*blanc, white, wit, bianco, weiß*

|     |     |    |        |         |
|-----|-----|----|--------|---------|
| 60W | E27 | 10 | 930.30 | 93030.4 |
|-----|-----|----|--------|---------|

*noir, black, zwart, nero, schwarz*

|     |     |    |        |         |
|-----|-----|----|--------|---------|
| 60W | E27 | 10 | 930.10 | 93010.6 |
|-----|-----|----|--------|---------|

**Rosette de dérivation en plafond**  
**Ceiling junction box**  
**plafondkap**  
**Presse di distribuzione a soffitto**  
**Decken-Verteilerdose**



*blanc, white, wit, bianco, weiß*

|   |      |   |      |         |
|---|------|---|------|---------|
| - | 10 x | 1 | 1812 | 01812.5 |
|---|------|---|------|---------|



*blanc, white, wit, bianco, weiß*

|   |   |    |        |         |
|---|---|----|--------|---------|
| - | - | 10 | 952.30 | 95230.6 |
|---|---|----|--------|---------|



**Monture pendulaire**  
**Suspension Set**  
**pendelophanging**  
**Attacco a pendolo**  
**Pendelaufhängung**

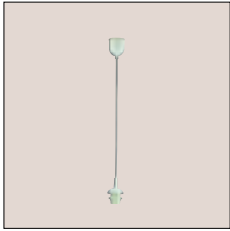

*blanc, white, wit, bianco, weiß*

|           |     |       |   |    |        |         |
|-----------|-----|-------|---|----|--------|---------|
| max. 100W | E27 | 700mm | ✓ | 10 | 910.30 | 91030.6 |
|-----------|-----|-------|---|----|--------|---------|

**Monte et baisse**  
**Suspension Set**  
**trekpendel**  
**Pendente con filo a spirale**  
**Rollzug**



*noir, black, zwart, nero, schwarz*

|           |     |       |  |    |        |         |
|-----------|-----|-------|--|----|--------|---------|
| max. 100W | E27 | 130cm |  | 10 | 900.10 | 90010.9 |
|-----------|-----|-------|--|----|--------|---------|

*brun, brown, bruin, marrone, braun*

|           |     |       |  |    |        |         |
|-----------|-----|-------|--|----|--------|---------|
| max. 100W | E27 | 130cm |  | 10 | 900.20 | 90020.8 |
|-----------|-----|-------|--|----|--------|---------|

*blanc, white, wit, bianco, weiß*

|           |     |       |  |    |        |         |
|-----------|-----|-------|--|----|--------|---------|
| max. 100W | E27 | 130cm |  | 10 | 900.30 | 90030.7 |
|-----------|-----|-------|--|----|--------|---------|

*doré, gold, goud, dorato, gold*

|           |     |       |  |    |        |         |
|-----------|-----|-------|--|----|--------|---------|
| max. 100W | E27 | 130cm |  | 10 | 900.40 | 90040.6 |
|-----------|-----|-------|--|----|--------|---------|

**Veilleuse**  
**Night-light**  
**nachtlampje**  
**Lumino da notte**  
**Nachtlicht**



*blanc, white, wit, bianco, weiß*

|    |   |   |  |    |        |         |
|----|---|---|--|----|--------|---------|
| 1W | - | - |  | 25 | 925.00 | 92500.3 |
|----|---|---|--|----|--------|---------|



*blanc, white, wit, bianco, weiß*

|    |   |   |  |    |        |         |
|----|---|---|--|----|--------|---------|
| 1W | - | - |  | 25 | 925.01 | 92501.0 |
|----|---|---|--|----|--------|---------|

**Fiche à angle**  
**Plug**  
**stekker geard**  
**Spina angolare con contatto di terra**  
**Schutzkontakt-Winkelstecker**



*blanc, white, wit, bianco, weiß*

|   |    |             |         |
|---|----|-------------|---------|
| - | 20 | <b>1829</b> | 01829.3 |
|---|----|-------------|---------|

*noir, black, zwart, nero, schwarz*

|   |    |             |         |
|---|----|-------------|---------|
| - | 10 | <b>1831</b> | 01831.6 |
|---|----|-------------|---------|

**Multiprise Schuko avec câble 150cm**  
**Table socket with 150cm cable**  
**tafelcontactdoos geard, met kabel 150 cm**  
**Presada tavolo con contatto di terra, con cavo 150cm**  
**Schutzkontakt-Tischsteckdose, mit Kabel 150cm**

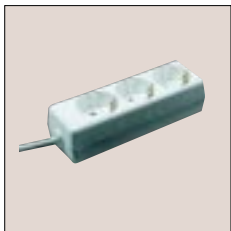

*blanc, white, wit, bianco, weiß*

|       |    |               |         |
|-------|----|---------------|---------|
| 3500W | 25 | <b>971.30</b> | 97130.7 |
|-------|----|---------------|---------|



*noir, black, zwart, nero, schwarz*

|       |    |               |         |
|-------|----|---------------|---------|
| 3500W | 25 | <b>971.20</b> | 97120.8 |
|-------|----|---------------|---------|

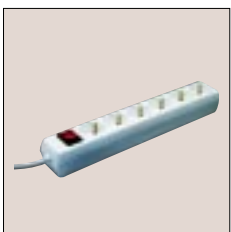

*blanc, white, wit, bianco, weiß*

|       |    |               |         |
|-------|----|---------------|---------|
| 3500W | 15 | <b>973.30</b> | 97330.1 |
|-------|----|---------------|---------|



*blanc, white, wit, bianco, weiß*

|       |    |               |         |
|-------|----|---------------|---------|
| 3500W | 15 | <b>975.30</b> | 97530.5 |
|-------|----|---------------|---------|



**Cordon avec fiche Euro, H 03 VV-F 3x0,75**  
**Extension lead with plug, H 03 VV-F 3x0,75**  
**verlengsnoer met geaarde stekker, H03 W-F 3x0,75**  
**Conduttore con spina con contatto di terra, H 03 VV-F 3x0,75**  
**Zuleitung mit Schutzkontaktstecker, H 03 VV-F 3x0,75**

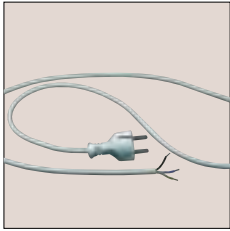

*blanc, white, wit, bianco, weiß*

|      |    |        |         |
|------|----|--------|---------|
| 1,5m | 10 | 913.30 | 91330.7 |
|------|----|--------|---------|

**Cordon avec fiche Euro, H 03 VV H2-F 2x0,75**  
**Extension Lead with Euro Plug, H 03 VV H2-F 2x0,75**  
**snoer met Eurocontactstop, H 03 VV H2-F 2x0,75**  
**Conduttore con spina Euro, H 03 VV H2-F 2x0,75**  
**Zuleitung mit Eurostecker, H 03 VV H2-F 2x0,75**

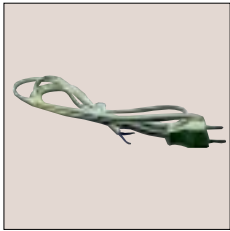

*blanc, white, wit, bianco, weiß*

|    |    |      |         |
|----|----|------|---------|
| 2m | 10 | 1856 | 01856.9 |
| 3m | 10 | 1857 | 01857.6 |

**Cordon avec fiche Euro et interrupteur, H 03 VV H2-F**  
**Extension Lead with 2-pin Plug & Switch, H 03 VV H2-F**  
**snoer met Eurocontactstop en schakelaar, H 03 VV H2-F**  
**Conduttore con spina Euro ed interruttore intermedio, H 03 VV H2-F**  
**Zuleitung mit Eurostecker und Zwischenschalter, H 03 VV H2-F**

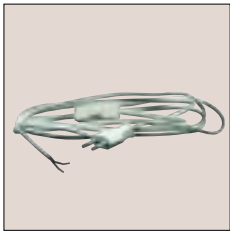

*blanc, white, wit, bianco, weiß*

|      |    |        |         |
|------|----|--------|---------|
| 2,5m | 10 | 913.33 | 91333.8 |
|------|----|--------|---------|

**Ralonge Euro H03 VV H2F 2x0,76**  
**Euro-Extension Cable H03 VV H2F 2x0,75**  
**Euroverlengsnoer H03 VV H2F 2x0,75**  
**Prolunga Euro H03 VV H2F 2x0,75**  
**Euroverlängerung H03 VV H2F 2x0,75**



*blanc, white, wit, bianco, weiß*

|    |    |        |         |
|----|----|--------|---------|
| 2m | 10 | 953.32 | 95332.7 |
| 4m | 10 | 953.34 | 95334.1 |

**Ralonge**  
**Extension lead**  
**verlengsnoer geaard**  
**Prolunga con contatto di terra**  
**Schutzkontakt-Verlängerung**



*blanc, white, wit, bianco, weiß*

|    |    |      |         |
|----|----|------|---------|
| 3m | 10 | 1859 | 01859.0 |
| 5m | 10 | 1860 | 01860.6 |



**Douille métal avec mise à la terre, M10x1**  
**Earthed Metal Lamp-Holder, M10x1**  
**metalen lamphouder met randaarde, M10x1**  
**Portalampada in metallo con messa a terra, M10x1**  
**Metallfassung mit Erdung, M10x1**



*laitoné, brass-plated, vermessingd, ottonato, vermessingt*

|     |    |      |         |
|-----|----|------|---------|
| E27 | 30 | 1861 | 01861.3 |
| E14 | 20 | 1864 | 01864.4 |

**Douille, M10x1**  
**Base, M10x1**  
**lamphouder, M10x1**  
**Portalampada, M10x1**  
**Fassung, M10x1**



*blanc, white, wit, bianco, weiß*

|     |    |      |         |
|-----|----|------|---------|
| E27 | 50 | 1865 | 01865.1 |
|-----|----|------|---------|

*noir, black, zwart, nero, schwarz*

|     |    |      |         |
|-----|----|------|---------|
| E27 | 50 | 1866 | 01866.8 |
|-----|----|------|---------|



*blanc, white, wit, bianco, weiß*

|     |   |      |         |
|-----|---|------|---------|
| E14 | 1 | 1867 | 01867.5 |
|-----|---|------|---------|

**Douille à chemise fileté avec mise à la terre, M10x1, avec écrou**  
**Threaded Lamp-Holder with earth connection, M10x1, with screw-ring**  
**schroeflamphouder, met randaarde, M10x1, met schroefring**  
**Portalampada a ghiera filettata, con messa a terra, M10x1, con cerchi a vite**  
**Schraubfassung, mit Erdung, M10x1, mit Schraubring**

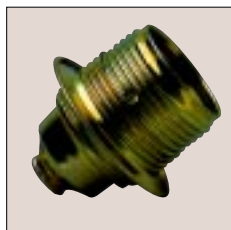

*laitoné, brass-plated, vermessingd, ottonato, vermessingt*

|     |    |      |         |
|-----|----|------|---------|
| E27 | 20 | 1870 | 01870.5 |
|-----|----|------|---------|

**Douille à chemise fileté, pack de 3, avec écrou**  
**Threaded Lamp-Holder, pack of 3, with screw-ring**  
**schroeflamphouder, 3-pack, met schroefring**  
**Portalampada a ghiera filettata, confezione da 3, con cerchi a vite**  
**Schraubfassung, 3er-Pack, mit Schraubring**



*blanc, white, wit, bianco, weiß*

|     |   |      |         |
|-----|---|------|---------|
| E27 | 1 | 1873 | 01873.6 |
|-----|---|------|---------|



**Douille céramique avec étrier de fixation, pack de 3**  
**Ceramic Lamp-holder with metal bar, pack of 3**  
**keramische lamphouder, met metalen beugel, 3-pack**  
**Portalampada di ceramica con attacco, confezione da 3**  
**Keramikfassung, mit Metallbügel, 3er-Pack**



*blanc, white, wit, bianco, weiß*

|     |   |   |   |      |         |
|-----|---|---|---|------|---------|
| E27 | - | - | 1 | 1893 | 01893.4 |
|-----|---|---|---|------|---------|

**Douille pour flamme réglable en hauteur, pack de 3**  
**Candle Holder, height adjustable, pack of 3**  
**kaarslamphouder, in hoogte verstelbaar, 3-pack**  
**Portalampada a candela, regolabile in altezza, confezione da 3**  
**Kerzenfassung, höhenverstellbar, 3er-Pack**



*noir, black, zwart, nero, schwarz*

|     |           |   |   |      |         |
|-----|-----------|---|---|------|---------|
| E14 | 80-100mm  | - | 1 | 1897 | 01897.2 |
| E14 | 100-120mm | - | 1 | 1898 | 01898.9 |

**Fourreau fausse bougie avec gouttes, pack de 10**  
**Candle Covers with Drips, pack of 10**  
**kaarshulzen, met druppels, 10-pack**  
**Fodero a forma di candela con gocce, confezione da 10, confezione da 10**  
**Kerzenhülsen, mit Tropfen, 10er-Pack**



*blanc, white, wit, bianco, weiß*

|     |       |   |   |      |         |
|-----|-------|---|---|------|---------|
| E14 | 100mm | - | 1 | 1901 | 01901.6 |
|-----|-------|---|---|------|---------|

*ivoire, ivory, ivoor, color avorio, elfenbein*

|     |       |   |   |      |         |
|-----|-------|---|---|------|---------|
| E14 | 100mm | - | 1 | 1902 | 01902.3 |
|-----|-------|---|---|------|---------|

*antique, antique, antiek, color anticato, antik*

|     |       |   |   |      |         |
|-----|-------|---|---|------|---------|
| E14 | 100mm | - | 1 | 1903 | 01903.0 |
|-----|-------|---|---|------|---------|

**Interrupteur à bascule, pack de 2**  
**Switch, pack of 2**  
**Tussenschakelaar, 2-pack**  
**Interruttore intermedio Wipp, confezione da 2**  
**Wipp-Zwischenschalter, 2er-Pack**



*blanc, white, wit, bianco, weiß*

|   |   |        |   |      |         |
|---|---|--------|---|------|---------|
| - | - | 2 Amp. | 1 | 1906 | 01906.1 |
|---|---|--------|---|------|---------|

*noir, black, zwart, nero, schwarz*

|   |   |        |   |      |         |
|---|---|--------|---|------|---------|
| - | - | 2 Amp. | 1 | 1907 | 01907.8 |
|---|---|--------|---|------|---------|

*doré, gold, goud, dorato, gold*

|   |   |        |   |      |         |
|---|---|--------|---|------|---------|
| - | - | 2 Amp. | 1 | 1909 | 01909.2 |
|---|---|--------|---|------|---------|





**Testeur d'ampoules, E14, E27, ampoules halogène**  
**Light-Bulb Tester, E14, E27, halogen lamps**  
**lampentester, E14, E27, halogeenlampen**  
**Apparecchio-verifica funzionamento per lampade ad incandescenza, E14, E27, lampade alogene**  
**Glühlampen-Durchgangsprüfgerät, E14, E27, Halogenlampen**



*blanc, white, wit, bianco, weiß*

|                         |   |     |         |
|-------------------------|---|-----|---------|
| E27, E14, Halogenlampen | 1 | 222 | 00222.3 |
|-------------------------|---|-----|---------|



*bleu, blue, blauw, blu, blau*

|                         |   |     |         |
|-------------------------|---|-----|---------|
| E27, E14, Halogenlampen | 1 | 225 | 00225.4 |
|-------------------------|---|-----|---------|

**Support de présentation pour ampoules**  
**Lamp holder**  
**lampenhouder**  
**Supporto per lampade ad incandescenza**  
**Glühlampenhalter**



*noir, black, zwart, nero, schwarz*

|     |   |     |         |
|-----|---|-----|---------|
| E14 | 1 | 248 | 00248.3 |
| E27 | 1 | 249 | 00249.0 |

Toutes les données et informations concernant les produits contenus dans ce catalogue sont susceptibles de varier. Nous nous réservons le droit de modifier les caractéristiques de nos produits sans préavis. Nous livrons à nos conditions de paiement et de livraison.

All pictures and details concerning dimensions, colour etc. are subject to variations in production and are not binding. We reserve the right to make alterations to products. We deliver according to our terms of delivery and payment.

Alle afbeeldingen en gegevens met betrekking tot maten, kleur enz. kunnen eventueel produktietechnisch vrijblijvend afwijken. Wij leveren conform onze leverings- en betalingscondities.

Z przyczyn technicznych wszystkie dane dotyczące wymiarów, koloru itd. mogą ulec ewentualnym odchyleniom i są niezobowiązujące. Zastrzegamy sobie prawo wprowadzania zmian w produktach. Dostarczamy towar według naszych warunków dostaw i opłat.

Alle afbildninger og angivelser mht. størrelser, farve osv. ligger under for evt. produktionstekniske tolerancer og er uforpligtende. Produktændringer kan forekomme. Vi leverer til vores leverings- og betalingsbetingelser

Tutte le foto e i dati riguardanti volume, colore, ecc. possono essere soggetti a delle correzioni tecniche di produzione e non sono impegnative. Ci riserviamo il diritto di apportare in ogni momento dei cambiamenti di produzione. Consegniamo alle nostre condizioni di consegna e pagamento

Todas las fotos y datos técnicos como medidas, colores etc. son variables debido a tolerancias en el proceso de producción. Modificaciones de los productos son posibles. Suministramos a base de nuestras condiciones de suministro y pago.

Všechna zobrazení a údaje týkající se rozměrů, barvy atd. podléhají eventuálním výrobně-technickým tolerancím a jsou nezávazné. Změna výrobků vyhrazena. Dodáváme podle našich dodavatelských a platebních podmínek.

Все изображения и данные относительно размеров, цвета и т.д. подлежат предварительному техническому допуску и не являются обязательными. Мы поставляем на наших условиях поставки и оплаты.

Alle Abbildungen und Angaben bezüglich Maße, Farbe usw. unterliegen eventuellen produktionstechnischen Toleranzen und sind unverbindlich. Produktänderungen behalten wir uns jederzeit vor. Wir liefern zu unseren Liefer- und Zahlungsverbindungen.

|         |      |        |       |        |     |         |    |        |       |         |       |         |       |         |    |          |     |
|---------|------|--------|-------|--------|-----|---------|----|--------|-------|---------|-------|---------|-------|---------|----|----------|-----|
| article | page | 133.27 | 12    | 191.47 | 10  | 300.40  | 14 | 432.40 | 4,16  | 521.40  | 24    | 801.10  | 42    | 831.519 | 70 | 834.07   | 91  |
|         |      | 133.40 | 11    | 191.67 | 10  | 301.00  | 14 | 432.41 | 4,16  | 523.40  | 24    | 801.20  | 42    | 831.529 | 70 | 834.09   | 90  |
| 100.00  | 2    | 133.47 | 12    | 191.70 | 2   | 301.40  | 14 | 432.60 | 4,16  | 530.00  | 53    | 808.10  | 43,47 | 831.56  | 71 | 834.10   | 90  |
| 100.40  | 2    | 133.60 | 11    | 191.74 | 2   | 301.60  | 14 | 432.61 | 4,16  | 530.01  | 53    | 810.10  | 42,49 | 831.579 | 70 | 834.16   | 90  |
| 100.60  | 2    | 133.67 | 12    | 191.76 | 2   | 302.20  | 14 | 433.00 | 26    | 530.02  | 53    | 8200    | 120   | 831.70  | 69 | 834.17   | 92  |
| 100.70  | 2    | 134.20 | 11,17 | 192.67 | 10  | 302.40  | 14 | 433.01 | 47    | 531.00  | 53    | 8201    | 120   | 831.71  | 93 | 834.18   | 90  |
| 101.001 | 2    | 134.40 | 11,17 | 193.47 | 10  | 303.00  | 14 | 433.02 | 26    | 533.00  | 24    | 820.10  | 42    | 831.72  | 93 | 834.19   | 92  |
| 101.21  | 2    | 135.20 | 11    | 193.67 | 10  | 303.40  | 14 | 433.40 | 26    | 540.20  | 43    | 820.20  | 42    | 831.73  | 93 | 834.20   | 90  |
| 101.401 | 2    | 135.27 | 12    | 195.27 | 10  | 303.60  | 14 | 433.41 | 47    | 540.21  | 47    | 8203    | 120   | 831.74  | 93 | 834.209  | 90  |
| 101.601 | 2    | 135.40 | 11    | 195.47 | 10  | 3223    | 96 | 433.42 | 26    | 540.22  | 44    | 820.40  | 42    | 831.75  | 93 | 834.25   | 90  |
| 101.701 | 2    | 135.47 | 12    | 196.27 | 10  | 3224    | 97 | 433.60 | 26    | 540.40  | 43    | 8205    | 120   | 831.76  | 93 | 834.27   | 91  |
| 102.00  | 2    | 136.20 | 11    | 196.47 | 10  | 3230    | 97 | 433.61 | 47    | 540.41  | 47    | 8207    | 120   | 831.77  | 93 | 834.30   | 90  |
| 102.20  | 2    | 136.27 | 12    | 200.01 | 33  | 400.21  | 50 | 433.62 | 26    | 540.42  | 44    | 8211    | 121   | 831.78  | 93 | 834.3019 | 91  |
| 102.40  | 2    | 136.40 | 11    | 200.02 | 34  | 400.22  | 50 | 433.70 | 26    | 541.20  | 44    | 822.20  | 74    | 831.88  | 94 | 834.302  | 91  |
| 102.60  | 2    | 136.47 | 12    | 200.03 | 33  | 400.23  | 50 | 433.71 | 47    | 541.40  | 44    | 822.21  | 74    | 831.89  | 94 | 834.3079 | 91  |
| 103.01  | 3,25 | 136.60 | 11    | 200.04 | 34  | 400.24  | 50 | 433.72 | 26    | 545.20  | 43    | 822.22  | 76    | 831.90  | 93 | 834.309  | 90  |
| 103.20  | 2    | 140.00 | 8     | 200.05 | 33  | 400.41  | 50 | 441.41 | 46    | 545.40  | 43    | 822.23  | 76    | 831.91  | 93 | 834.50   | 90  |
| 103.21  | 3,25 | 140.40 | 8     | 200.06 | 34  | 400.42  | 50 | 443.20 | 18    | 546.20  | 43    | 822.24  | 75    | 831.92  | 93 | 834.5079 | 91  |
| 103.40  | 2    | 140.60 | 8     | 200.07 | 34  | 400.43  | 50 | 443.40 | 18    | 548.40  | 28,30 | 822.26  | 75    | 831.93  | 93 | 834.509  | 90  |
| 103.41  | 3,25 | 141.00 | 8     | 200.08 | 33  | 400.44  | 50 | 443.60 | 18    | 548.60  | 28,30 | 822.27  | 76    | 831.94  | 93 | 834.60   | 92  |
| 103.60  | 2    | 141.09 | 9     | 200.10 | 34  | 401.21  | 48 | 444.08 | 18    | 549.10  | 43    | 822.29  | 76    | 831.95  | 93 | 834.61   | 92  |
| 103.61  | 3,25 | 141.40 | 8     | 200.20 | 35  | 401.22  | 48 | 444.20 | 18    | 550.40  | 31    | 822.30  | 74    | 831.96  | 94 | 834.70   | 92  |
| 104.20  | 3,16 | 141.49 | 9     | 200.21 | 35  | 401.23  | 48 | 444.40 | 18    | 550.60  | 31    | 822.31  | 74    | 831.97  | 94 | 835.10   | 101 |
| 104.21  | 3,16 | 141.60 | 8     | 200.22 | 35  | 401.24  | 48 | 444.41 | 46    | 551.20  | 18,32 | 822.32  | 75    | 831.98  | 94 | 835.11   | 101 |
| 104.40  | 3,16 | 141.61 | 7     | 200.28 | 35  | 401.31  | 48 | 444.60 | 18    | 551.40  | 18,32 | 822.33  | 75    | 831.99  | 94 | 835.13   | 101 |
| 104.41  | 3,16 | 141.69 | 9     | 200.40 | 35  | 401.32  | 48 | 448.10 | 18    | 552.20  | 22,32 | 822.39  | 76    | 832.20  | 78 | 835.18   | 101 |
| 104.60  | 3,16 | 142.40 | 8     | 200.41 | 35  | 401.33  | 48 | 448.20 | 18    | 552.40  | 22,32 | 823.29  | 80    | 832.21  | 78 | 835.19   | 101 |
| 104.61  | 3,16 | 142.41 | 7     | 200.42 | 35  | 401.34  | 48 | 448.22 | 18    | 553.20  | 32    | 823.39  | 80    | 832.22  | 84 | 835.50   | 101 |
| 105.20  | 3    | 142.49 | 9     | 200.45 | 35  | 402.21  | 49 | 448.40 | 18    | 553.40  | 32    | 823.59  | 80    | 832.24  | 83 | 835.51   | 101 |
| 105.40  | 3    | 142.60 | 8     | 200.48 | 35  | 402.22  | 49 | 448.42 | 18    | 554.40  | 32    | 823.93  | 80    | 832.26  | 83 | 835.52   | 101 |
| 106.20  | 3    | 142.61 | 7     | 200.60 | 35  | 402.23  | 49 | 448.60 | 18    | 554.60  | 32    | 823.95  | 80    | 832.27  | 83 | 835.53   | 101 |
| 106.40  | 3    | 142.69 | 9     | 201.21 | 51  | 402.24  | 49 | 449.08 | 18    | 555.40  | 31    | 829.14  | 72    | 832.28  | 83 | 835.58   | 101 |
| 106.60  | 3    | 143.20 | 8     | 201.22 | 51  | 407.40  | 28 | 449.10 | 18    | 555.60  | 31    | 829.17  | 72    | 832.29  | 83 | 835.59   | 101 |
| 110.60  | 5    | 143.29 | 9     | 201.23 | 51  | 407.60  | 28 | 449.20 | 18    | 556.40  | 31    | 829.24  | 72    | 832.30  | 78 | 835.60   | 101 |
| 111.60  | 5    | 143.40 | 8     | 201.24 | 51  | 408.20  | 19 | 449.22 | 18    | 556.60  | 31    | 829.27  | 72    | 832.31  | 78 | 835.61   | 101 |
| 112.40  | 5    | 143.49 | 9     | 202.30 | 35  | 408.40  | 19 | 449.40 | 18    | 560.20  | 20    | 829.30  | 73    | 832.32  | 84 | 835.70   | 101 |
| 113.00  | 5,25 | 143.60 | 8     | 207.20 | 35  | 410.00  | 28 | 449.42 | 18    | 560.40  | 20    | 829.31  | 73    | 832.34  | 83 | 835.71   | 101 |
| 113.20  | 5,25 | 144.20 | 8     | 207.40 | 35  | 410.40  | 28 | 449.60 | 18    | 561.27  | 20    | 829.33  | 73    | 832.36  | 83 | 835.78   | 101 |
| 113.40  | 5,25 | 144.21 | 7     | 207.60 | 35  | 410.60  | 28 | 450.20 | 22    | 561.47  | 20    | 829.34  | 73    | 832.37  | 83 | 835.79   | 101 |
| 113.60  | 5,25 | 144.29 | 9     | 208.01 | 102 | 411.20  | 19 | 450.40 | 22    | 562.20  | 19    | 829.42  | 73    | 832.38  | 83 | 835.80   | 100 |
| 117.10  | 5,15 | 144.40 | 8     | 208.02 | 102 | 411.40  | 19 | 450.60 | 22    | 562.21  | 19    | 829.43  | 73    | 832.39  | 83 | 835.81   | 100 |
| 117.20  | 5,15 | 144.41 | 7     | 208.03 | 102 | 412.20  | 17 | 451.20 | 22    | 562.29  | 19    | 829.54  | 72    | 832.50  | 78 | 836.01   | 98  |
| 117.22  | 15   | 144.49 | 9     | 208.04 | 102 | 412.40  | 17 | 451.40 | 22    | 562.40  | 19    | 829.55  | 72    | 832.51  | 78 | 836.02   | 98  |
| 117.40  | 5,15 | 145.20 | 8,17  | 208.05 | 102 | 416.00  | 47 | 451.41 | 46    | 562.41  | 19    | 830.09  | 90    | 832.52  | 84 | 836.03   | 98  |
| 117.42  | 15   | 145.40 | 8,17  | 208.35 | 102 | 416.40  | 47 | 451.42 | 46    | 562.49  | 19    | 830.10  | 67    | 832.54  | 83 | 836.04   | 98  |
| 117.60  | 5,15 | 149.20 | 8     | 208.50 | 102 | 416.60  | 47 | 451.60 | 22    | 563.29  | 24    | 830.11  | 92    | 832.55  | 89 | 836.05   | 98  |
| 118.10  | 5,15 | 149.40 | 8     | 209.35 | 103 | 416.70  | 47 | 451.62 | 46    | 563.49  | 24    | 830.16  | 92    | 832.56  | 83 | 836.06   | 98  |
| 118.20  | 5,15 | 149.49 | 9     | 209.50 | 103 | 417.00  | 47 | 452.20 | 22    | 563.69  | 24    | 830.20  | 67    | 832.57  | 83 | 836.07   | 97  |
| 118.21  | 46   | 149.60 | 8     | 217    | 123 | 417.40  | 47 | 452.40 | 22    | 565.20  | 23    | 830.209 | 89    | 832.58  | 83 | 836.08   | 97  |
| 118.40  | 5,15 | 149.69 | 9     | 218    | 123 | 417.60  | 47 | 453.40 | 23    | 565.21  | 23    | 830.21  | 90    | 832.59  | 83 | 836.09   | 96  |
| 118.41  | 46   | 150.60 | 13    | 218.9  | 123 | 417.70  | 47 | 453.47 | 23    | 565.27  | 23    | 830.25  | 77    | 832.62  | 84 | 836.10   | 96  |
| 118.60  | 5,15 | 151.60 | 13    | 220.20 | 36  | 418.00  | 27 | 453.60 | 23    | 565.40  | 23    | 830.26  | 77    | 832.63  | 84 | 836.11   | 95  |
| 118.61  | 46   | 151.67 | 13    | 220.40 | 36  | 418.02  | 27 | 460.40 | 28,50 | 565.41  | 23    | 830.27  | 74    | 832.65  | 84 | 836.12   | 95  |
| 121.00  | 6    | 153.60 | 13    | 220.42 | 36  | 418.10  | 27 | 460.60 | 28,50 | 565.47  | 23    | 830.28  | 79    | 832.72  | 84 | 836.13   | 95  |
| 121.40  | 6    | 154.60 | 13    | 220.48 | 36  | 418.150 | 27 | 470.00 | 28    | 565.61  | 23    | 830.299 | 89    | 832.73  | 84 | 836.14   | 95  |
| 121.60  | 6    | 154.67 | 13    | 220.60 | 36  | 418.20  | 27 | 470.60 | 28    | 565.67  | 23    | 830.30  | 69    | 832.75  | 84 | 836.15   | 95  |
| 122.40  | 6    | 178.00 | 117   | 220.62 | 36  | 418.200 | 27 | 491.20 | 20    | 590.70  | 54    | 830.31  | 90    | 832.92  | 84 | 836.16   | 95  |
| 122.60  | 6    | 178.02 | 118   | 220.68 | 36  | 418.22  | 27 | 491.40 | 20    | 591.70  | 54    | 830.35  | 77    | 832.93  | 84 | 836.17   | 95  |
| 123.02  | 6,25 | 178.03 | 117   | 222    | 132 | 418.40  | 27 | 500.00 | 39    | 592.70  | 54,60 | 830.36  | 77    | 832.95  | 84 | 836.18   | 95  |
| 123.22  | 6,25 | 178.06 | 118   | 225    | 132 | 418.42  | 27 | 500.70 | 39    | 593.20  | 54,61 | 830.37  | 74    | 833.05  | 77 | 836.20   | 99  |
| 123.40  | 6    | 178.08 | 118   | 227.40 | 36  | 418.45  | 27 | 501.60 | 39    | 593.40  | 54,61 | 830.38  | 79    | 833.07  | 81 | 836.21   | 99  |
| 123.42  | 6,25 | 178.10 | 118   | 227.60 | 36  | 418.60  | 27 | 501.70 | 39    | 700.60  | 30    | 830.50  | 69    | 833.19  | 77 | 836.22   | 99  |
| 123.60  | 6    | 178.12 | 118   | 229.50 | 103 | 418.62  | 27 | 502.40 | 39    | 720.20  | 44    | 830.51  | 90    | 833.197 | 79 | 836.23   | 99  |
| 123.62  | 6,25 | 178.14 | 119   | 230.41 | 51  | 418.65  | 27 | 502.60 | 39    | 720.21  | 44    | 830.55  | 77    | 833.199 | 77 | 836.36   | 97  |
| 125.20  | 6    | 178.15 | 114   | 230.42 | 51  | 418.70  | 27 | 503.10 | 37    | 720.40  | 44    | 830.56  | 77    | 833.21  | 81 | 836.37   | 96  |
| 125.40  | 6    | 178.19 | 114   | 230.43 | 51  | 419.00  | 27 | 503.20 | 37    | 720.41  | 44    | 830.58  | 79    | 833.27  | 81 | 836.50   | 97  |
| 127.08  | 15   | 178.24 | 122   | 230.44 | 52  | 419.02  | 27 | 503.25 | 41    | 720.60  | 44    | 831.00  | 69    | 833.299 | 77 | 836.56   | 97  |
| 127.10  | 15   | 178.34 | 122   | 230.46 | 52  | 419.10  | 27 | 503.26 | 41    | 720.75  | 44    | 831.01  | 70    | 833.31  | 81 | 836.57   | 96  |
| 127.20  | 15   | 178.35 | 122   | 240.00 | 36  | 419.150 | 27 | 503.27 | 41    | 721.60  | 44    | 831.02  | 70    | 833.37  | 81 | 837.10   | 100 |
| 127.22  | 15   | 178.48 | 114   | 240.20 | 36  | 419.20  | 27 | 503.30 | 37    | 730.20  | 45    | 831.05  | 67    | 833.399 | 77 | 837.11   | 100 |
| 127.40  | 15   | 178.50 | 114   | 240.40 | 36  | 419.200 | 27 | 503.34 | 38    | 730.30  | 45    | 831.052 | 68    | 833.41  | 88 | 837.15   | 100 |
| 127.42  | 15   | 178.51 | 114   | 240.60 | 36  | 419.22  | 27 | 503.39 | 38    | 730.301 | 45    | 831.057 | 68    | 833.42  | 88 | 837.16   | 100 |
| 127.60  | 15   | 178.63 | 115   | 240.70 | 36  | 419.40  | 27 | 503.40 | 37    | 730.60  | 45    | 831.059 | 67    | 833.43  | 88 | 837.25   | 100 |
| 128.08  | 15   | 1812   | 126   | 248    | 132 | 419.42  | 27 |        |       |         |       |         |       |         |    |          |     |

|        |    |          |    |          |       |        |    |        |     |         |     |          |     |          |      |        |    |
|--------|----|----------|----|----------|-------|--------|----|--------|-----|---------|-----|----------|-----|----------|------|--------|----|
| 840.21 | 90 | 881.30   | 60 | 8833.389 | 78    | 885.20 | 61 | 894.17 | 55  | 977.04  | 114 | 977.93   | 109 | 979.26   | 111  | 984.57 | 65 |
| 840.26 | 77 | 882.07   | 59 | 8833.39  | 78    | 885.36 | 61 | 894.19 | 55  | 977.05  | 114 | 977.94   | 109 | 979.29   | 123  | 984.86 | 65 |
| 840.27 | 74 | 882.09   | 59 | 8833.391 | 41,79 | 885.58 | 61 | 894.21 | 55  | 977.07  | 114 | 977.95   | 109 | 979.30   | 111  | 984.89 | 65 |
| 840.30 | 69 | 882.11   | 59 | 8833.397 | 79    | 887.16 | 60 | 900.10 | 127 | 977.08  | 114 | 977.96   | 110 | 979.33   | 113  | 984.90 | 65 |
| 840.31 | 90 | 882.15   | 59 | 8833.399 | 78    | 890.07 | 57 | 900.20 | 127 | 977.09  | 114 | 977.97   | 110 | 979.36   | 111  | 984.91 | 65 |
| 840.36 | 77 | 882.16   | 59 | 8833.509 | 78    | 890.09 | 57 | 900.30 | 127 | 977.15  | 108 | 978.01   | 116 | 979.38   | 113  | 984.92 | 65 |
| 840.37 | 74 | 882.21   | 59 | 8833.557 | 79    | 890.11 | 57 | 900.40 | 127 | 977.16  | 107 | 978.019  | 116 | 979.40   | 111  | 984.93 | 65 |
| 840.50 | 69 | 882.23   | 59 | 8833.559 | 78    | 890.15 | 57 | 910.30 | 127 | 977.20  | 108 | 978.02   | 116 | 979.42   | 110  | 984.94 | 65 |
| 840.51 | 90 | 882.90   | 59 | 8833.589 | 78    | 890.20 | 57 | 913.30 | 129 | 977.25  | 108 | 978.029  | 116 | 979.500  | 111  | 984.95 | 64 |
| 840.56 | 77 | 882.91   | 59 | 8833.59  | 78    | 891.03 | 57 | 913.33 | 129 | 977.28  | 106 | 978.039  | 117 | 979.51   | 112  | 984.96 | 65 |
| 842.14 | 74 | 882.95   | 59 | 8833.591 | 41,79 | 891.05 | 57 | 920.30 | 126 | 977.29  | 106 | 978.31   | 116 | 979.56   | 111  | 984.97 | 65 |
| 842.24 | 77 | 882.97   | 59 | 8833.597 | 79    | 891.07 | 57 | 925.00 | 127 | 977.30  | 106 | 978.33   | 116 | 979.60   | 111  | 988.00 | 86 |
| 842.34 | 77 | 883.14   | 56 | 8833.599 | 78    | 891.15 | 57 | 925.01 | 127 | 977.31  | 106 | 978.41   | 116 | 979.62   | 110  | 988.01 | 86 |
| 842.54 | 77 | 883.15   | 56 | 8833.79  | 78    | 891.17 | 57 | 926.00 | 127 | 977.36  | 108 | 978.44   | 116 | 979.73   | 125  | 988.02 | 86 |
| 843.14 | 67 | 883.20   | 56 | 8838.297 | 75    | 891.19 | 57 | 930.10 | 126 | 977.51  | 107 | 978.45   | 116 | 979.75   | 125  | 988.03 | 86 |
| 843.24 | 67 | 8833.209 | 78 | 8838.299 | 74    | 892.05 | 58 | 930.30 | 126 | 977.53  | 107 | 979.01   | 117 | 979.78   | 111  | 988.05 | 86 |
| 843.34 | 69 | 8833.219 | 87 | 8838.397 | 75    | 892.07 | 58 | 952.30 | 126 | 977.54  | 107 | 979.02   | 110 | 979.79   | 111  | 988.06 | 86 |
| 843.54 | 69 | 8833.229 | 87 | 8838.399 | 74    | 892.15 | 58 | 953.32 | 129 | 977.70  | 124 | 979.05   | 123 | 979.82   | 125  | 988.07 | 86 |
| 843.91 | 68 | 8833.239 | 87 | 884.00   | 60    | 892.17 | 58 | 953.34 | 129 | 977.71  | 108 | 979.051  | 123 | 979.83   | 125  | 988.08 | 86 |
| 843.92 | 68 | 8833.249 | 87 | 884.15   | 59    | 892.20 | 58 | 960.01 | 112 | 977.72  | 107 | 979.0529 | 123 | 979.84   | 125  | 988.09 | 86 |
| 843.93 | 68 | 8833.25  | 78 | 884.20   | 59    | 892.25 | 58 | 960.09 | 112 | 977.759 | 124 | 979.0569 | 123 | 979.85   | 125  | 988.21 | 85 |
| 843.94 | 68 | 8833.269 | 87 | 884.22   | 62    | 892.27 | 58 | 960.39 | 111 | 977.799 | 124 | 979.057  | 123 | 979.9919 | 113  | 988.22 | 85 |
| 843.95 | 68 | 8833.289 | 78 | 884.25   | 59    | 892.29 | 58 | 960.40 | 111 | 977.81  | 108 | 979.061  | 123 | 979.9929 | 113  | 988.24 | 85 |
| 844.14 | 92 | 8833.29  | 78 | 884.32   | 61    | 893.05 | 56 | 960.41 | 111 | 977.82  | 108 | 979.065  | 123 | 979.9939 | 113, | 988.26 | 85 |
| 844.24 | 92 | 8833.291 | 79 | 884.40   | 61    | 893.07 | 56 | 961.01 | 60  | 977.83  | 108 | 979.066  | 123 |          | 124  | 988.36 | 85 |
| 845.34 | 90 | 8833.297 | 79 | 884.45   | 62    | 893.15 | 56 | 971.20 | 128 | 977.84  | 106 | 979.067  | 123 | 979.9949 | 113, | 988.51 | 85 |
| 845.54 | 90 | 8833.299 | 78 | 884.80   | 62    | 893.16 | 56 | 971.30 | 128 | 977.85  | 110 | 979.08   | 116 |          | 124  | 988.52 | 85 |
| 880.05 | 60 | 8833.309 | 78 | 885.04   | 61    | 893.17 | 56 | 973.30 | 128 | 977.86  | 110 | 979.11   | 111 | 979.9969 | 113  | 988.54 | 85 |
| 880.07 | 60 | 883.3319 | 87 | 885.06   | 61    | 893.18 | 56 | 975.06 | 114 | 977.87  | 107 | 979.12   | 113 | 979.9979 | 113  | 988.56 | 85 |
| 880.09 | 60 | 883.3329 | 87 | 885.08   | 61    | 894.05 | 55 | 975.16 | 115 | 977.88  | 107 | 979.13   | 123 | 979.9989 | 113, |        |    |
| 880.11 | 60 | 883.3339 | 87 | 885.13   | 61    | 894.07 | 55 | 975.17 | 115 | 977.89  | 107 | 979.15   | 111 |          | 124  |        |    |
| 881.10 | 60 | 8833.349 | 87 | 885.15   | 61    | 894.09 | 55 | 975.30 | 128 | 977.90  | 108 | 979.20   | 111 | 984.25   | 64   |        |    |



| No.     | Energy | Lum. | h    | No.    | Energy | Lum. | h    | No.    | Energy | Lum. | h    | No.    | Energy | Lum. | h    |
|---------|--------|------|------|--------|--------|------|------|--------|--------|------|------|--------|--------|------|------|
| 100.00  | G      | 1000 | 1500 | 121.40 | F      | 350  | 1000 | 135.20 | F      | 200  | 1000 | 150.60 | G      | 500  | 1500 |
| 100.40  | G      | 300  | 1500 | 121.60 | F      | 630  | 1000 | 135.27 | F      | 180  | 1000 | 151.60 | G      | 500  | 1000 |
| 100.60  | F      | 600  | 1500 | 122.40 | F      | 350  | 1000 | 135.40 | F      | 335  | 1000 | 151.67 | G      | 500  | 1000 |
| 100.70  | F      | 850  | 1500 | 122.60 | F      | 630  | 1000 | 135.47 | G      | 300  | 1000 | 153.60 | G      | 500  | 1500 |
| 101.001 | G      | 1000 | 1000 | 123.40 | E      | 410  | 1000 | 136.20 | F      | 200  | 1000 | 154.60 | G      | 500  | 1000 |
| 101.401 | F      | 320  | 1000 | 123.60 | E      | 700  | 1000 | 136.27 | F      | 180  | 1000 | 154.67 | G      | 500  | 1000 |
| 101.601 | F      | 600  | 1000 | 125.20 | E      | 225  | 1000 | 136.40 | F      | 335  | 1000 | 191.47 | G      | 300  | 1000 |
| 101.701 | F      | 800  | 1000 | 125.40 | E      | 410  | 1000 | 136.47 | G      | 300  | 1000 | 191.67 | F      | 600  | 1000 |
| 102.00  | G      | 1000 | 1000 | 127.08 | E      | 40   | 1000 | 136.60 | F      | 575  | 1000 | 191.70 | G      | 1000 | 1000 |
| 102.20  | F      | 180  | 1000 | 127.10 | F      | 85   | 1000 | 140.00 | G      | 1000 | 1500 | 191.74 | F      | 320  | 1000 |
| 102.40  | G      | 300  | 1000 | 127.20 | E      | 225  | 1000 | 140.40 | G      | 300  | 1500 | 191.76 | F      | 600  | 1000 |
| 102.60  | F      | 600  | 1000 | 127.40 | E      | 410  | 1000 | 140.60 | F      | 600  | 1500 | 192.67 | F      | 600  | 1000 |
| 103.20  | F      | 200  | 1000 | 127.60 | E      | 700  | 1000 | 141.00 | G      | 1000 | 1000 | 193.47 | G      | 300  | 1000 |
| 103.40  | F      | 335  | 1000 | 128.08 | E      | 40   | 1000 | 141.09 | G      | 1000 | 1000 | 193.67 | F      | 600  | 1000 |
| 103.60  | F      | 575  | 1000 | 128.10 | F      | 85   | 1000 | 141.40 | G      | 300  | 1000 | 195.27 | F      | 180  | 1000 |
| 104.20  | F      | 200  | 1000 | 128.20 | E      | 225  | 1000 | 141.49 | G      | 300  | 1000 | 195.47 | G      | 300  | 1000 |
| 104.21  | E      | 220  | 1000 | 128.21 | E      | 225  | 1000 | 141.60 | F      | 600  | 1000 | 196.27 | F      | 180  | 1000 |
| 104.40  | F      | 335  | 1000 | 128.40 | E      | 410  | 1000 | 141.61 | F      | 630  | 1000 | 196.47 | G      | 300  | 1000 |
| 104.41  | F      | 370  | 1000 | 128.41 | E      | 400  | 1000 | 141.69 | F      | 600  | 1000 | 400.21 | G      | 85   | 1000 |
| 104.60  | F      | 575  | 1000 | 128.60 | E      | 700  | 1000 | 142.40 | G      | 300  | 1000 | 400.22 | F      | 170  | 1000 |
| 104.61  | F      | 630  | 1000 | 128.61 | E      | 660  | 1000 | 142.41 | F      | 330  | 1000 | 400.23 | G      | 28   | 1000 |
| 105.20  | F      | 200  | 1000 | 130.00 | F      | 1100 | 1500 | 142.49 | G      | 300  | 1000 | 400.24 | G      | 28   | 1000 |
| 105.40  | F      | 335  | 1000 | 130.07 | G      | 1000 | 1500 | 142.60 | F      | 600  | 1000 | 400.41 | G      | 150  | 1000 |
| 106.20  | F      | 200  | 1000 | 130.60 | F      | 630  | 1500 | 142.61 | F      | 630  | 1000 | 400.42 | F      | 320  | 1000 |
| 106.40  | F      | 335  | 1000 | 130.67 | F      | 600  | 1500 | 142.69 | F      | 600  | 1000 | 400.43 | G      | 50   | 1000 |
| 106.60  | F      | 575  | 1000 | 131.00 | F      | 1100 | 1000 | 143.20 | F      | 180  | 1000 | 400.44 | G      | 47   | 1000 |
| 110.60  | E      | 700  | 1500 | 131.07 | G      | 1000 | 1000 | 143.29 | E      | 225  | 1000 | 401.21 | G      | 60   | 1000 |
| 111.60  | E      | 660  | 1000 | 131.40 | F      | 330  | 1000 | 143.40 | G      | 300  | 1000 | 401.22 | G      | 160  | 1000 |
| 112.40  | F      | 350  | 1000 | 131.47 | G      | 300  | 1000 | 143.49 | E      | 410  | 1000 | 401.23 | G      | 35   | 1000 |
| 117.10  | F      | 85   | 1000 | 131.60 | F      | 630  | 1000 | 143.60 | F      | 600  | 1000 | 401.24 | G      | 25   | 1000 |
| 117.20  | E      | 225  | 1000 | 131.67 | F      | 630  | 1000 | 144.20 | F      | 180  | 1000 | 401.31 | G      | 60   | 1000 |
| 117.22  | E      | 225  | 1000 | 132.40 | F      | 330  | 1000 | 144.21 | E      | 225  | 1000 | 401.32 | G      | 160  | 1000 |
| 117.40  | E      | 410  | 1000 | 132.47 | G      | 300  | 1000 | 144.29 | E      | 225  | 1000 | 401.33 | G      | 35   | 1000 |
| 117.42  | E      | 410  | 1000 | 132.60 | F      | 630  | 1000 | 144.40 | G      | 300  | 1000 | 401.34 | G      | 25   | 1000 |
| 117.60  | E      | 700  | 1000 | 132.67 | F      | 600  | 1000 | 144.41 | F      | 335  | 1000 | 402.21 | G      | 60   | 1000 |
| 118.10  | F      | 85   | 1000 | 133.20 | F      | 200  | 1000 | 144.49 | E      | 410  | 1000 | 402.22 | G      | 160  | 1000 |
| 118.20  | E      | 225  | 1000 | 133.27 | F      | 180  | 1000 | 145.20 | F      | 180  | 1000 | 402.23 | G      | 35   | 1000 |
| 118.21  | F      | 200  | 1000 | 133.40 | F      | 335  | 1000 | 145.40 | G      | 300  | 1000 | 402.24 | G      | 25   | 1000 |
| 118.40  | E      | 410  | 1000 | 133.47 | G      | 300  | 1000 | 149.20 | F      | 180  | 1000 | 407.40 | F      | 340  | 1000 |
| 118.41  | E      | 400  | 1000 | 133.60 | F      | 575  | 1000 | 149.40 | G      | 300  | 1000 | 407.60 | F      | 600  | 1000 |
| 118.60  | E      | 700  | 1000 | 133.67 | F      | 600  | 1000 | 149.49 | F      | 360  | 1000 | 408.20 | F      | 170  | 1000 |
| 118.61  | E      | 660  | 1000 | 134.20 | F      | 200  | 1000 | 149.60 | F      | 560  | 1000 | 408.40 | F      | 340  | 1000 |
| 121.00  | F      | 1050 | 1000 | 134.40 | F      | 335  | 1000 | 149.69 | E      | 700  | 1000 | 410.00 | F      | 1100 | 1000 |

| No.     | Energy | Lum. | h    | No.    | Energy | Lum. | h    | No.      | Energy | Lum. | h    | No.    | Energy | Lum. | h    |
|---------|--------|------|------|--------|--------|------|------|----------|--------|------|------|--------|--------|------|------|
| 410.40  | F      | 340  | 1000 | 448.40 | E      | 410  | 1000 | 563.29   | E      | 225  | 1000 | 835.13 | E      | 1450 | 2000 |
| 410.60  | F      | 600  | 1000 | 448.42 | E      | 410  | 1000 | 563.49   | E      | 410  | 1000 | 835.18 | D      | 1600 | 2000 |
| 411.20  | F      | 170  | 1000 | 448.60 | E      | 700  | 1000 | 563.69   | E      | 700  | 1000 | 835.19 | E      | 1450 | 2000 |
| 411.40  | F      | 340  | 1000 | 449.08 | E      | 40   | 1000 | 565.20   | E      | 225  | 1000 | 835.50 | D      | 2500 | 2000 |
| 412.20  | G      | 150  | 1000 | 449.10 | F      | 85   | 1000 | 565.21   | E      | 225  | 1000 | 835.51 | D      | 2400 | 2000 |
| 412.40  | F      | 340  | 1000 | 449.20 | E      | 225  | 1000 | 565.27   | F      | 200  | 1000 | 835.52 | E      | 3900 | 1500 |
| 416.00  | E      | 1380 | 1000 | 449.40 | E      | 410  | 1000 | 565.40   | E      | 410  | 1000 | 835.53 | E      | 2100 | 2000 |
| 416.40  | E      | 430  | 1000 | 449.60 | E      | 700  | 1000 | 565.41   | E      | 410  | 1000 | 835.58 | D      | 2550 | 2000 |
| 416.60  | E      | 730  | 1000 | 450.20 | E      | 225  | 1000 | 565.47   | F      | 370  | 1000 | 835.59 | E      | 2100 | 2000 |
| 416.70  | E      | 960  | 1000 | 450.40 | E      | 410  | 1000 | 565.61   | E      | 700  | 1000 | 835.60 | D      | 900  | 2000 |
| 417.00  | E      | 1380 | 1000 | 450.60 | E      | 700  | 1000 | 565.67   | F      | 600  | 1000 | 835.61 | D      | 840  | 2000 |
| 417.40  | E      | 430  | 1000 | 451.20 | E      | 225  | 1000 | 590.70   | G      | 105  | 1000 | 835.70 | D      | 1100 | 2000 |
| 417.60  | E      | 730  | 1000 | 451.40 | E      | 410  | 1000 | 591.70   | G      | 65   | 1000 | 835.71 | D      | 1050 | 2000 |
| 417.70  | E      | 960  | 1000 | 451.41 | E      | 410  | 1000 | 700.60   | G      | 120  | 1000 | 835.78 | D      | 840  | 2000 |
| 418.00  | E      | 1330 | 1000 | 451.42 | E      | 410  | 1000 | 720.20   | F      | 180  | 1000 | 835.79 | E      | 780  | 2000 |
| 418.02  | E      | 1330 | 1000 | 451.60 | E      | 700  | 1000 | 720.21   | G      | 150  | 1000 | 836.09 | E      | 330  | 1500 |
| 418.10  | F      | 85   | 1000 | 452.20 | F      | 180  | 1000 | 720.40   | F      | 360  | 1000 | 836.10 | E      | 520  | 1500 |
| 418.150 | E      | 2220 | 1000 | 452.40 | F      | 360  | 1000 | 720.41   | F      | 360  | 1000 | 836.11 | E      | 350  | 1500 |
| 418.20  | E      | 225  | 1000 | 453.40 | E      | 410  | 1000 | 720.60   | F      | 600  | 1000 | 836.12 | E      | 340  | 1500 |
| 418.200 | E      | 3150 | 1000 | 453.47 | F      | 360  | 1000 | 720.75   | G      | 520  | 1000 | 836.13 | E      | 550  | 1500 |
| 418.22  | E      | 225  | 1000 | 453.60 | E      | 700  | 1000 | 721.60   | F      | 600  | 1000 | 836.14 | E      | 530  | 1500 |
| 418.40  | E      | 410  | 1000 | 470.00 | G      | 900  | 1000 | 730.20   | G      | 840  | 1000 | 837.10 | E      | 1320 | 1500 |
| 418.60  | E      | 700  | 1000 | 470.60 | F      | 600  | 1000 | 730.30   | F      | 270  | 1000 | 837.11 | E      | 1320 | 1500 |
| 418.70  | E      | 940  | 1000 | 491.20 | F      | 180  | 1000 | 730.301  | G      | 240  | 1000 | 837.15 | E      | 2250 | 1500 |
| 419.00  | E      | 1330 | 1000 | 491.40 | F      | 360  | 1000 | 730.60   | G      | 420  | 1000 | 837.16 | E      | 2250 | 1500 |
| 419.10  | F      | 85   | 1000 | 510.20 | E      | 225  | 1000 | 730.601  | G      | 420  | 1000 | 837.25 | E      | 3850 | 1500 |
| 419.150 | E      | 2220 | 1000 | 510.21 | E      | 225  | 1000 | 740.65   | E      | 660  | 1000 | 837.45 | D      | 490  | 1500 |
| 419.20  | E      | 225  | 1000 | 510.40 | E      | 410  | 1000 | 740.66   | E      | 660  | 1000 | 837.65 | D      | 840  | 2000 |
| 419.200 | E      | 3150 | 1000 | 510.41 | E      | 410  | 1000 | 800.10   | F      | 90   | 1000 | 837.70 | E      | 950  | 1500 |
| 419.40  | E      | 410  | 1000 | 512.20 | E      | 225  | 1000 | 800.11   | G      | 26   | 1000 | 837.71 | E      | 950  | 1500 |
| 419.60  | E      | 700  | 1000 | 512.40 | E      | 410  | 1000 | 800.12   | F      | 80   | 1000 | 839.00 | E      | 1320 | 1500 |
| 419.70  | E      | 940  | 1000 | 513.20 | E      | 225  | 1000 | 800.13   | G      | 45   | 1000 | 839.15 | E      | 2250 | 1500 |
| 430.00  | F      | 1200 | 1000 | 513.40 | E      | 410  | 1000 | 800.20   | F      | 165  | 1000 | 839.70 | E      | 950  | 1500 |
| 430.20  | F      | 200  | 1000 | 514.10 | F      | 85   | 1000 | 801.10   | F      | 90   | 1000 | 840.11 | E      | 1400 | 1000 |
| 430.40  | E      | 390  | 1000 | 514.20 | E      | 225  | 1000 | 801.20   | F      | 165  | 1000 | 840.16 | E      | 2300 | 1000 |
| 430.60  | E      | 660  | 1000 | 514.40 | E      | 410  | 1000 | 808.10   | G      | 75   | 1000 | 840.21 | E      | 3000 | 1000 |
| 430.70  | F      | 800  | 1000 | 514.60 | E      | 700  | 1000 | 810.10   | G      | 20   | 1000 | 840.31 | E      | 4600 | 1000 |
| 431.20  | F      | 200  | 1000 | 516.20 | E      | 225  | 1000 | 820.10   | F      | 85   | 1000 | 882.07 | A      | 350  | 8000 |
| 431.21  | E      | 220  | 1000 | 516.21 | F      | 200  | 1000 | 820.20   | F      | 185  | 1000 | 882.09 | A      | 450  | 8000 |
| 431.40  | F      | 335  | 1000 | 516.40 | E      | 410  | 1000 | 820.40   | E      | 410  | 1000 | 882.11 | A      | 600  | 8000 |
| 431.41  | F      | 370  | 1000 | 516.41 | F      | 335  | 1000 | 830.09   | D      | 1500 | 1500 | 882.15 | A      | 850  | 8000 |
| 431.60  | F      | 575  | 1000 | 521.20 | E      | 225  | 1000 | 830.11   | E      | 1250 | 1500 | 882.16 | A      | 850  | 8000 |
| 431.61  | F      | 630  | 1000 | 521.40 | E      | 410  | 1000 | 830.16   | E      | 2350 | 1500 | 882.21 | A      | 1200 | 8000 |
| 432.10  | G      | 75   | 1000 | 523.40 | E      | 410  | 1000 | 830.21   | E      | 2800 | 1500 | 882.23 | A      | 1450 | 8000 |
| 432.20  | F      | 200  | 1000 | 540.20 | G      | 160  | 1000 | 830.31   | E      | 4500 | 1500 | 882.90 | A      | 600  | 8000 |
| 432.21  | E      | 220  | 1000 | 540.21 | E      | 225  | 1000 | 831.90   | E      | 230  | 2000 | 882.91 | A      | 450  | 8000 |
| 432.40  | F      | 335  | 1000 | 540.22 | E      | 225  | 1000 | 831.91   | E      | 460  | 2000 | 882.95 | A      | 220  | 8000 |
| 432.41  | F      | 370  | 1000 | 540.40 | F      | 370  | 1000 | 831.92   | E      | 780  | 2000 | 882.97 | A      | 350  | 8000 |
| 432.60  | F      | 575  | 1000 | 540.41 | F      | 370  | 1000 | 834.010  | D      | 1550 | 2000 | 883.14 | B      | 420  | 8000 |
| 432.61  | F      | 630  | 1000 | 540.42 | F      | 370  | 1000 | 834.015  | D      | 2600 | 2000 | 883.15 | B      | 460  | 8000 |
| 433.00  | E      | 1350 | 1000 | 541.20 | G      | 160  | 1000 | 834.0159 | D      | 2600 | 2000 | 883.20 | B      | 850  | 8000 |
| 433.01  | E      | 1350 | 1000 | 541.40 | F      | 370  | 1000 | 834.020  | E      | 2800 | 2000 | 884.32 | B      | 2000 | 8000 |
| 433.02  | D      | 1500 | 1000 | 545.20 | G      | 160  | 1000 | 834.052  | D      | 2400 | 2000 | 884.40 | A      | 2800 | 8000 |
| 433.40  | E      | 420  | 1000 | 545.40 | F      | 370  | 1000 | 834.057  | E      | 2300 | 2000 | 884.45 | A      | 2700 | 8000 |
| 433.41  | D      | 470  | 1000 | 546.20 | G      | 160  | 1000 | 834.06   | E      | 1250 | 2000 | 885.04 | B      | 110  | 5000 |
| 433.42  | D      | 475  | 1000 | 548.40 | F      | 350  | 1000 | 834.07   | D      | 1500 | 2000 | 885.06 | B      | 220  | 5000 |
| 433.60  | E      | 720  | 1000 | 548.60 | G      | 500  | 1000 | 834.09   | D      | 1650 | 2000 | 885.08 | B      | 310  | 5000 |
| 433.61  | F      | 640  | 1000 | 549.10 | G      | 75   | 1000 | 834.16   | D      | 2500 | 2000 | 885.13 | A      | 700  | 5000 |
| 433.62  | D      | 800  | 1000 | 550.40 | F      | 330  | 1000 | 834.17   | E      | 1350 | 2000 | 885.15 | A      | 800  | 8000 |
| 433.70  | E      | 900  | 1000 | 550.60 | G      | 450  | 1000 | 834.18   | D      | 2400 | 2000 | 885.18 | A      | 1150 | 8000 |
| 433.71  | E      | 900  | 1000 | 551.20 | F      | 180  | 1000 | 834.19   | D      | 1550 | 2000 | 890.15 | B      | 480  | 8000 |
| 433.72  | E      | 1030 | 1000 | 551.40 | F      | 360  | 1000 | 834.20   | D      | 3400 | 2000 | 890.20 | B      | 520  | 8000 |
| 441.41  | E      | 410  | 1000 | 552.20 | F      | 180  | 1000 | 834.209  | D      | 3400 | 2000 | 891.05 | B      | 150  | 8000 |
| 443.20  | E      | 225  | 1000 | 552.40 | F      | 360  | 1000 | 834.25   | E      | 4000 | 2000 | 891.07 | B      | 200  | 8000 |
| 443.40  | E      | 410  | 1000 | 560.20 | F      | 200  | 1000 | 834.27   | E      | 3000 | 2000 | 891.15 | B      | 150  | 8000 |
| 443.60  | E      | 700  | 1000 | 560.40 | F      | 335  | 1000 | 834.30   | D      | 5250 | 2000 | 891.17 | B      | 200  | 8000 |
| 444.08  | E      | 40   | 1000 | 561.27 | F      | 180  | 1000 | 834.3019 | E      | 4600 | 2000 | 891.19 | B      | 300  | 8000 |
| 444.20  | E      | 225  | 1000 | 561.47 | F      | 360  | 1000 | 834.302  | E      | 4700 | 2000 | 893.05 | B      | 130  | 8000 |
| 444.40  | E      | 410  | 1000 | 562.20 | F      | 180  | 1000 | 834.3079 | E      | 4600 | 2000 | 893.07 | B      | 220  | 8000 |
| 444.41  | E      | 410  | 1000 | 562.21 | E      | 225  | 1000 | 834.309  | D      | 5250 | 2000 | 893.15 | B      | 130  | 8000 |
| 444.60  | E      | 700  | 1000 | 562.29 | E      | 225  | 1000 | 834.60   | D      | 860  | 2000 | 893.16 | B      | 400  | 8000 |
| 448.10  | F      | 85   | 1000 | 562.40 | F      | 360  | 1000 | 834.61   | D      | 860  | 2000 | 893.17 | B      | 220  | 8000 |
| 448.20  | E      | 225  | 1000 | 562.41 | E      | 410  | 1000 | 835.10   | D      | 1500 | 2000 | 893.18 | B      | 500  | 8000 |
| 448.22  | E      | 225  | 1000 | 562.49 | E      | 410  | 1000 | 835.11   | E      | 1430 | 2000 |        |        |      |      |